

Operating Instructions (EN)

MODELS:

Micro-HD

20"-26" Disk
25" Cylindrical
20", 24" & 28" Orbital

Mini-HD

26"-28" Disk
25"-29" Cylindrical
24"-28" Orbital

Mag-HD

30", 32" & 34" Disk
29"-33" Cylindrical
28"-32" Orbital

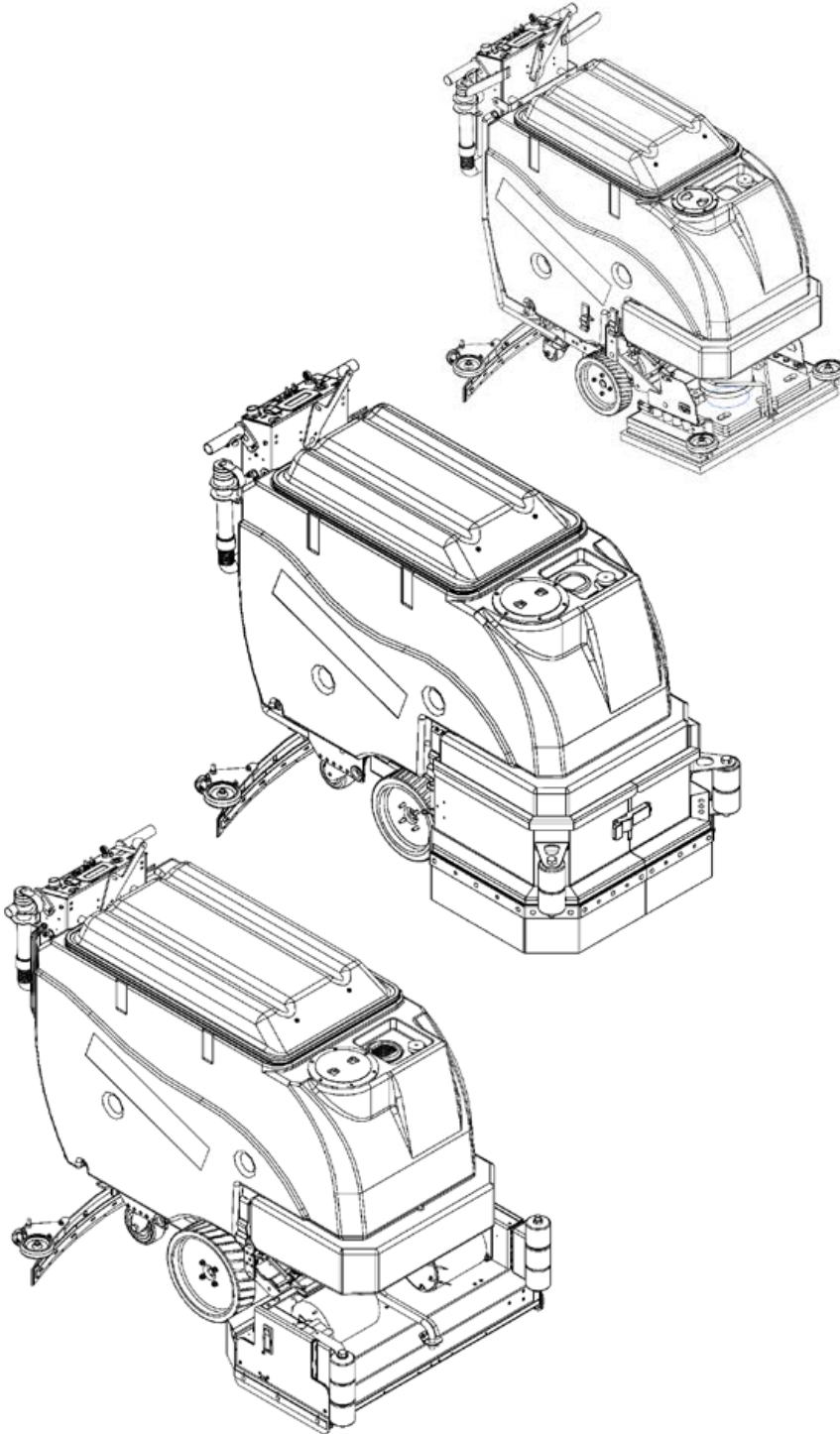

Read these Instructions before using the machine.



Read these Safety Messages before using the machine.

INTRODUCTION

This manual is furnished with each new machine. This manual will allow the Operator to get the best performance out of your RPS manufactured Scrubber-Drier, Sweeper, Burnisher, or Orbital Scrubber. Read this manual thoroughly before operating or servicing the machine.

This machine will provide excellent performance, but the best results will be obtained at the most minimum costs if:

- The machine is regularly maintained - per the Authorized Local Distributor.
- The machine is operated with reasonable care and caution.
- The machine is maintained with manufacturer supplied parts.

LOCATE SERIAL NUMBER

The serial number of your machine is located on the lower half of the control panel of the machine.

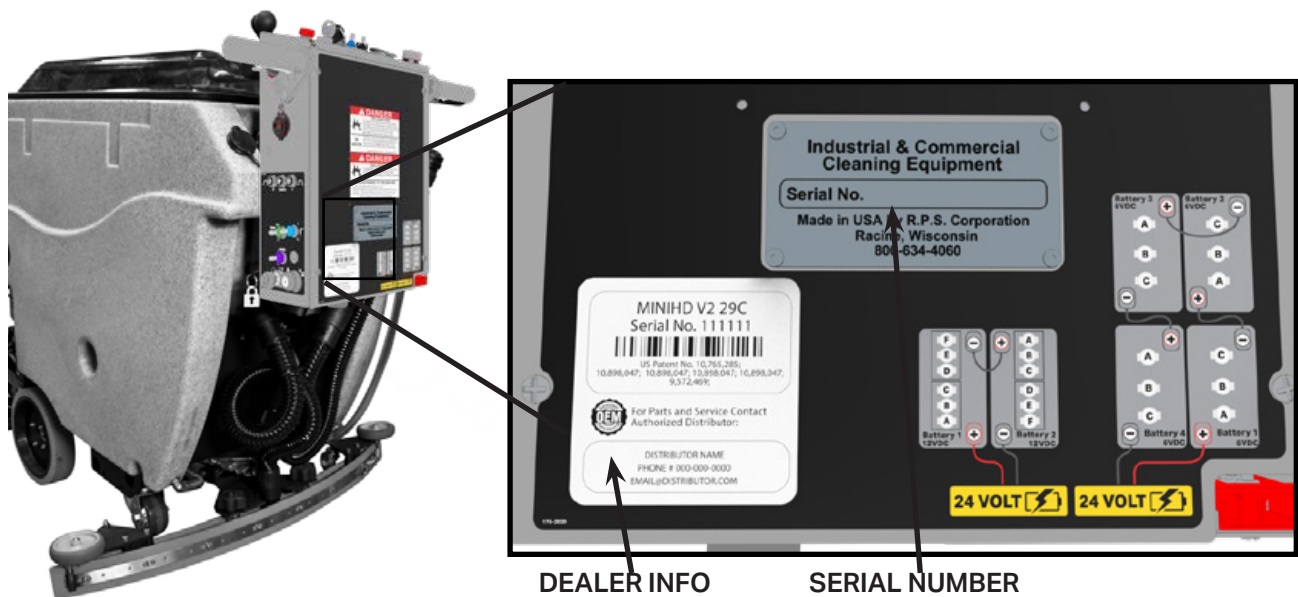

AS OUR POLICY IS ONE OF CONSTANT IMPROVEMENT - ALL INFORMATION AND SPECIFICATIONS ARE SUBJECT TO CHANGE WITHOUT NOTICE.

TABLE OF CONTENTS



Introduction.....	2	PM Sheet.....	38
Locate Serial Number.....	2	Membrane/Touch Screen Error Codes.....	40
Table Of Contents.....	3	Membrane/Touch Screen Error Codes.....	41
Safety Messages.....	4	Touch screen schematics.....	42
Safety Labels.....	6	Military grade schematic	43
Dashboard Controls (Military, Legacy, Touch Screen, membrane).....	7	Membrane Schematics.....	45
Central Command Side Panel Controls.....	8	Legacy schematic	46
legacy LCD Screen (Micro-HD/Mini-HD only).....	9	MACHINE DECALS.....	47
Touch Screen (Optional).....	10	Micro-HD Common Wear Parts.....	48
Membrane (Mag-HD only).....	14	Round Disk Brushes:.....	48
Battery Setup.....	18	Round Disk Pads:.....	48
install Squeegee.....	19	Cylindrical Brushes:.....	48
Adjust Squeegee.....	20	EDGE Pads and Screens:.....	48
Remove From Battery Charger.....	21	EDGE Grip Face:.....	49
Transportation - Forward.....	22	v2.1 Squeegee Blade Kits & Complete Squeegee	
Transportation - Reverse.....	23	Assemblies:.....	49
Fill Solution Tank.....	24	Mini-HD Common Wear Parts.....	50
Operation - Scrubbing.....	25	Round Disk Brushes:.....	50
Draining Recovery Tank.....	26	Round Disk Pads:.....	50
Draining Solution Tank.....	27	Cylindrical Brushes:.....	50
Flushing Recovery Tank.....	28	EDGE Pads and Screens:.....	50
Clean Drain Saver.....	29	EDGE Grip Face:.....	51
Clean Cylindrical Hopper.....	30	v2.1 Squeegee Blade Kits & Complete Squeegee	
Clean Vac Box System.....	31	Assemblies:.....	51
Remove Disk Brushes.....	32	Mag-HD Common Wear Parts.....	52
Remove Cylindrical Brushes.....	33	Round Disk Brushes:.....	52
Remove Orbital Pads.....	34	Round Disk Pads:.....	52
Charge Batteries.....	35	Cylindrical Brushes:.....	52
Battery Chargers.....	36	EDGE Pads and Screens:.....	52
Military Central Command status light codes	37	EDGE Grip Face:.....	53
		v2.1 Squeegee Blade Kits & Complete Squeegee	
		Assemblies:.....	53



SAFETY MESSAGES

You will see four kinds of safety reminders in this manual:

<p>⚠ DANGER</p> <p>DANGER indicates a hazardous situation which, if not avoided, will result in death or serious injury.</p>	<p>⚠ WARNING</p> <p>WARNING indicates a potentially hazardous situation which, if not avoided, could result in death or serious injury.</p>
<p>⚠ CAUTION</p> <p>CAUTION indicates a potentially hazardous situation which, if not avoided, could result in minor or moderate injury or damage to this machine or nearby objects. CAUTION also can be used to alert against unsafe practices.</p>	<p>NOTICE</p> <p>NOTICE indicates information considered important, but not hazard-related. This safety message may be related to property damage or warranty warnings.</p>

Your safety, and that of others, is very important. Operating this machine safely is an important responsibility.

DO NOT OPERATE THIS MACHINE:

- Unless you are trained and authorized to do so by your RPS Authorized Local Distributor
- Unless you have read and understood this Operator's Manual
- On surfaces with greater than a 2% grade unless this machine is equipped with a functional parking brake
- On surfaces with greater than an 8% grade at any time
- On Loading Docks

WHEN OPERATING THIS MACHINE:

- Remove loose objects from the floor that could be projected from the rotating Brushes
- Keep your hands and feet away from the rotating Brushes
- Do not operate this machine where flammable liquids, vapors, or dust are present
- Use caution when maneuvering

BEFORE LEAVING THE MACHINE:

- Drain "clean" Solution & "dirty" Recovery solution into APPROVED drains
- Park the machine on a level surface
- Turn the machine off & remove key

BEFORE SERVICING THE MACHINE:

- Disconnect the Batteries
- Drain both tanks

<p>⚠ DANGER</p> <p>Explosive hydrogen gas forms when Batteries are charging. An open flame or spark can cause this gas to explode. Serious personal injury or property damage could occur. Only charge the Batteries in this machine in a well ventilated area.</p>	<p>⚠ DANGER</p> <p>Flammable materials can cause an explosion or fire. Do not use flammable materials in Tank or pick up.</p>
--	--

! WARNING

The Batteries in this machine produce hazardous voltage which can cause electrical shock, burns and/or electrocution. Always disconnect Batteries before servicing this machine.

! WARNING

When climbing or descending ramps, always drive machine forward. To avoid overturning the machine, Do not back down ramps. Do not drive across inclines. Do not turn while ascending or descending ramps. Overturning the machine can cause serious injury or death.

! WARNING

Do not use water that exceeds 135°F / 57°C. If water is above said temperature, this will void the Tank Warranty.

! WARNING

Do not park this machine on ramps or slopes. Always park this machine on a level, hard surface. Do not operate this machine outdoors or on uneven surfaces.

! WARNING

The Batteries in this machine contain sulfuric acid, which causes burns to skin. If battery acid contacts clothing or skin, rinse the effected area with cold water immediately. If battery acid gets on your face or in your eyes, flush the area immediately with cold water and seek medical attention.

! WARNING

To avoid electrical shock, do not operate this machine over electrical floor outlets.

! CAUTION

To avoid damage to this machine, use only cleaning solutions and replacement parts recommended by the manufacturer.

! CAUTION

Do not operate this machine if any parts have been damaged or removed.

! WARNING

Dress safely. Do not wear rings or metal wrist watches when servicing this machine, as they can cause an electrical short circuit which can cause serious burns.

! WARNING

Do not remove, paint over or destroy warning decals. If warning decals become damaged, call 1-262-681-3583 for free replacements.

! WARNING

Dress safely. Do not wear a neck tie, scarf, or any loose or dangling clothing while operating this machine. Loose or dangling clothing or neck-wear can tangle in rotating parts, causing serious injury or death.

! WARNING

Always turn off this machine before leaving it unattended. Do not allow untrained persons to operate this machine.

! WARNING

NO RIDERS. Do not carry passengers on this machine. Do not use this machine as a stepladder or work platform.

! WARNING

Understand the dynamic braking system before you operate the machine on ramps. Machine may coast.

! WARNING

Before you service a Battery, always wear face protection, protective gloves and protective clothing. Battery acid or battery explosion can cause serious injuries.

! CAUTION

Always use the automatic battery charger provided by the manufacturer of this machine to charge the Batteries of this machine. It is designed to charge the Batteries at the appropriate rate. If you must use a different charger, disconnect the Batteries before charging to avoid damage to the electronic speed controller.

! CAUTION

To avoid damage to the electronic control components of this machine, Do not store this machine outdoors. Do not pressure wash this machine.



SAFETY LABELS

Read and obey all Safety Labels on your Floor Scrubber. If you have questions about these labels, ask your supervisor.

These images indicate where on the Floor Scrubber the Safety Labels are located. If ever the labels become illegible, worn off, or torn, promptly report it to your supervisor and replace it.

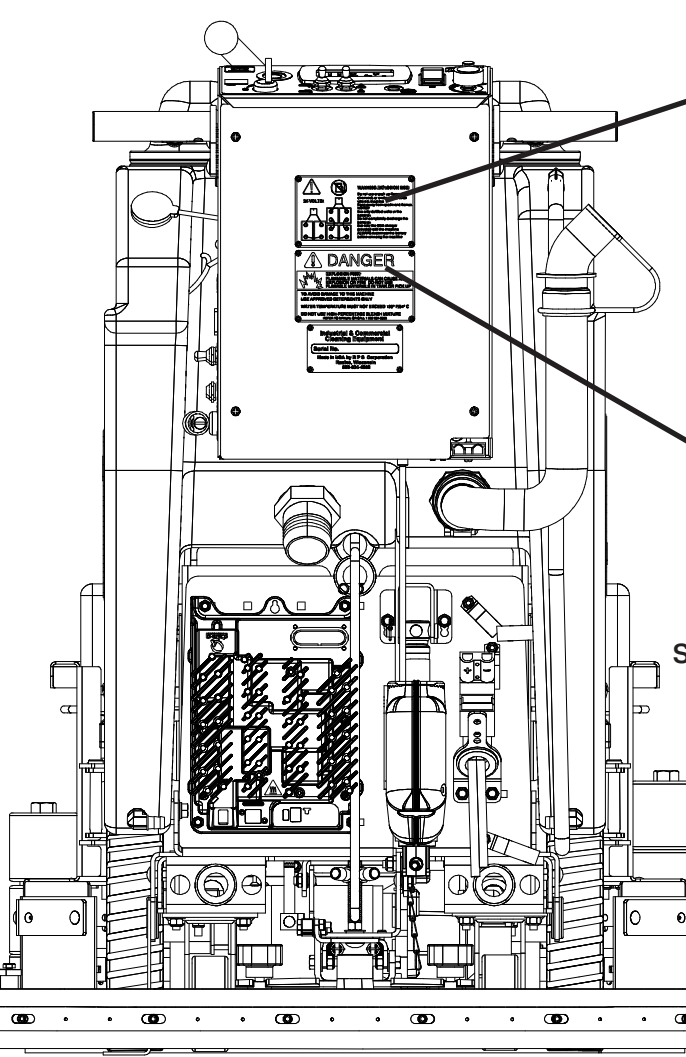

⚠ DANGER
EXPLOSION RISK!
EXPLOSIVE HYDROGEN GAS FORMS WHEN BATTERIES ARE CHARGING. AN OPEN FLAME OR SPARK CAN CAUSE THIS GAS TO EXPLODE. ONLY CHARGE THE BATTERIES IN THIS MACHINE IN A WELL VENTILATED AREA.

24 VOLTS!
USE ONLY DISTILLED WATER IN THE BATTERIES. USE ONLY THE OEM CHARGER PROVIDED WITH THE MACHINE. **ALWAYS** DISCONNECT THE BATTERY BEFORE SERVICING THE MACHINE.
REFER TO MANUAL OR CALL +001-262-681-3583

⚠ DANGER
EXPLOSION RISK!
FLAMMABLE MATERIALS CAN CAUSE AN EXPLOSION OR FIRE. DO NOT USE FLAMMABLE MATERIALS IN TANK OR PICK UP.

TO AVOID DAMAGE TO THIS MACHINE:

- USE APPROVED DETERGENTS ONLY
- WATER TEMPERATURE MUST NOT EXCEED 130°F/54°C
- DO NOT USE HIGH-PERCENTAGE BLEACH MIXTURE

REFER TO MANUAL OR CALL +001-262-681-3583

SEE BACK PAGE FOR DECAL PART NUMBERS

DASHBOARD CONTROLS (MILITARY, LEGACY, TOUCH SCREEN, MEMBRANE)

1. Squeegee Lever
2. Reverse Switch
3. Drive Switch (Both Handles)
4. E-Stop
5. Key Switch
6. Vac Clog Light
7. ZER03 Light
8. Speed Potentiometer
9. Vac Switch
10. Solution Switch +/-
11. Scrubdeck Switch +/-
12. Down pressure Switch
13. Military Flow Lever
14. Military Status Light
15. Military Battery Gauge / Hour Meter Combo
16. Military Down Pressure Gauge

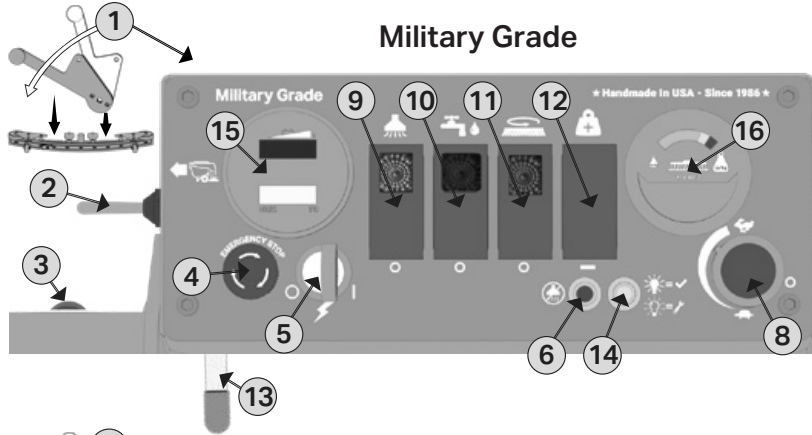

13. Military Flow Lever
14. Military Status Light
15. Military Battery Gauge / Hour Meter Combo
16. Military Down Pressure Gauge
17. LCD Screen
18. Legacy Hour Meter Button
19. Batteries
20. Vac Light
21. Solution Light
22. Scrubdeck

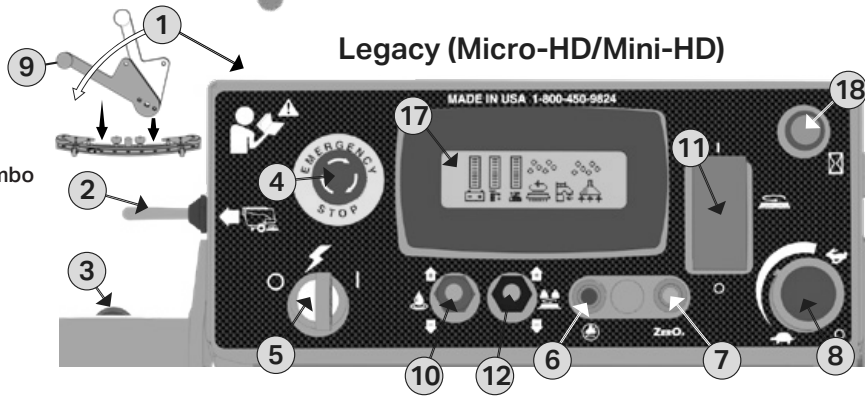

23. Zone 1
24. Zone 2
25. Zone 3
26. Suds (Off, Normal, 2x Dose)
27. Traction

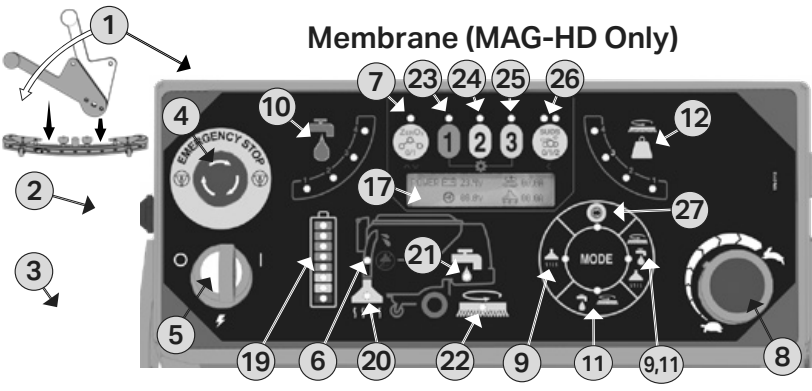
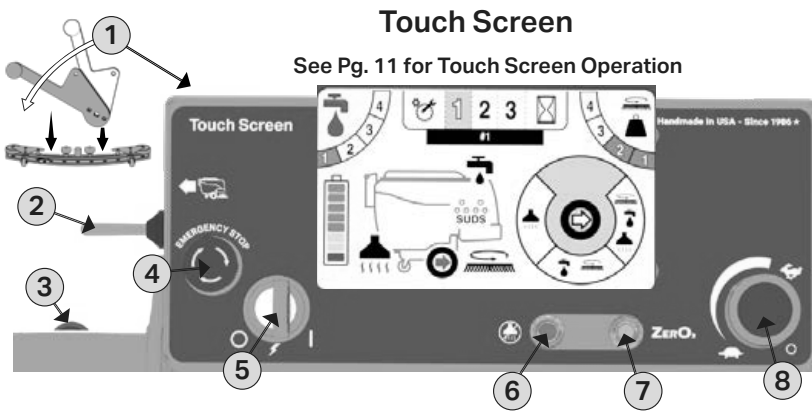

CENTRAL COMMAND SIDE PANEL CONTROLS

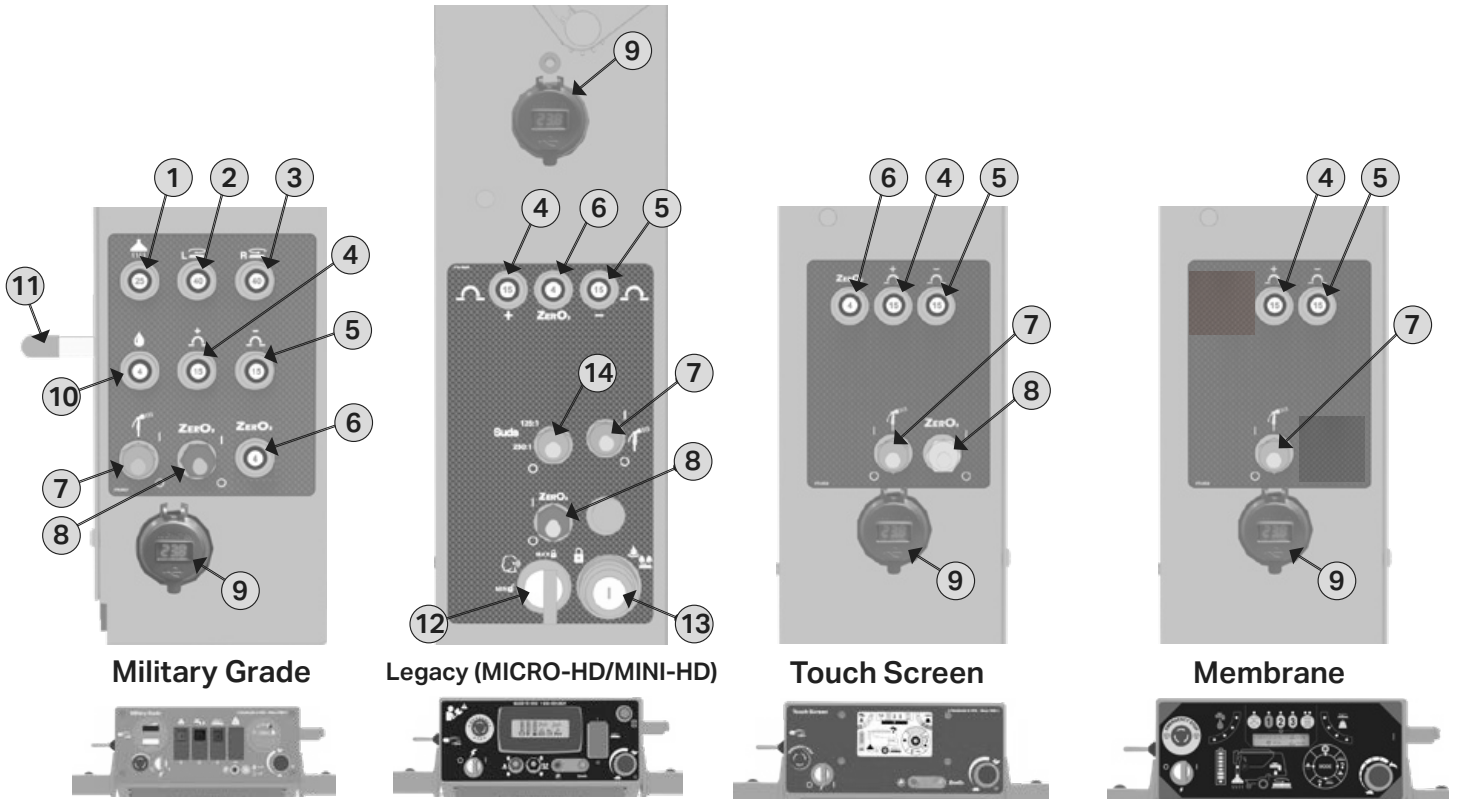

- | | | |
|---|---|---|
| <ul style="list-style-type: none"> 1. Vac Circuit Breaker 2. Left Brush Circuit Breaker 3. Right Brush Circuit Breaker 4. Positive BUSS Circuit Breaker 5. Negative BUSS Circuit Breaker | <ul style="list-style-type: none"> 6. ZER03 Circuit Breaker 7. Spray Jet On (I) / Off (O) 8. ZER03 On (I) / Off (O) 9. Dual USB Voltmeter 10. Solution Valve Circuit Breaker | <ul style="list-style-type: none"> 11. Military Solution Control Lever 12. Legacy ECON switch Max (locked) Min (unlocked) 13. Legacy Dual Manager Lockout Solution/Downpressure 14. Suds Switch 125:1/ 250:1/ Off (O) |
|---|---|---|

LEGACY LCD SCREEN (MICRO-HD/MINI-HD ONLY)



SCREEN #1 (OPERATOR)

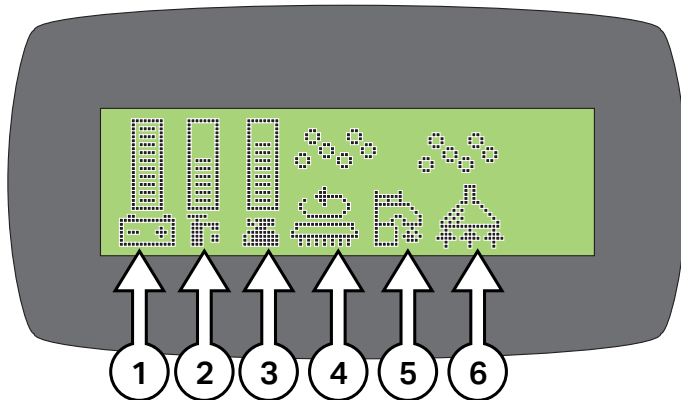

SCREEN #2 (MAINTENANCE)

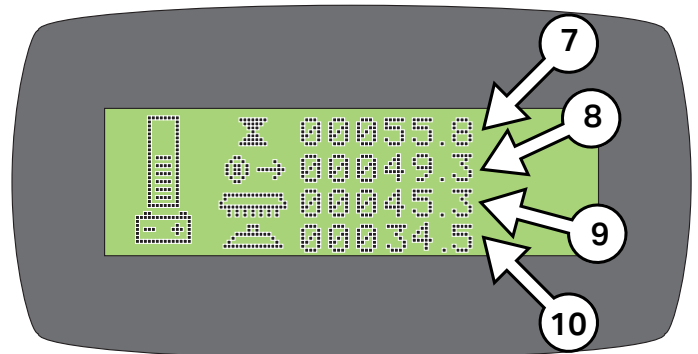

SCREEN #3 (WITH ERROR CODE)

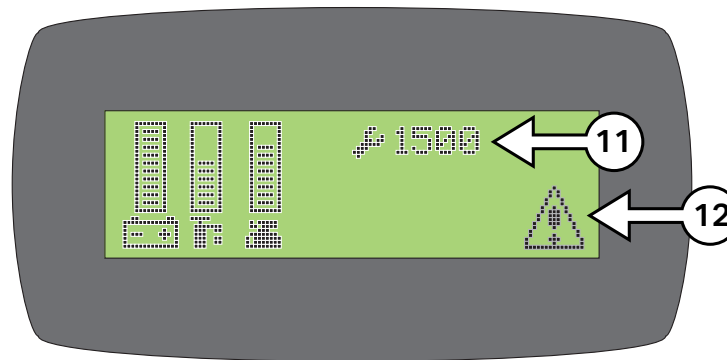

**** USE GREEN MENU SELECTION BUTTON ON CONTROL PANEL TO CHANGE SCREENS ****

1. **BATTERY LEVEL INDICATOR** - Indicates the energy level remaining in the Batteries (*Shown on all menu displays*)
2. **SOLUTION OUTPUT INDICATOR** - Indicates the gallons per minute (*GPM*) 0 - 1.0
3. **SCRUBDECK DOWN PRESSURE INDICATOR** - Sets the down pressure on the Brushes / Pads
4. **SCRUB MOTORS ON** - Indicates the Brush Motors are in operation
5. **SOLUTION ON** - Indicates the solution flow is *ON*
6. **VACUUM ON** - Indicates the Vacuum is *ON*
7. **KEY SWITCH HOUR METER** - Indicates total hours the machine has had keyswitch *ON*
8. **TRANSPORT HOUR METER** - Indicates total hours the drive system has been in operation
9. **SCRUB BRUSH HOUR METER** - Indicates total hours the brush motors have been in operation
10. **VACUUM HOUR METER** - Indicates total hours the vacuum motor has been used
11. **DIAGNOSTIC CODE** - Displays diagnostic code which helps troubleshoot issues
12. **ERROR WARNING SYMBOL** - Indicates when there has been a diagnostic code error

TOUCH SCREEN (OPTIONAL)

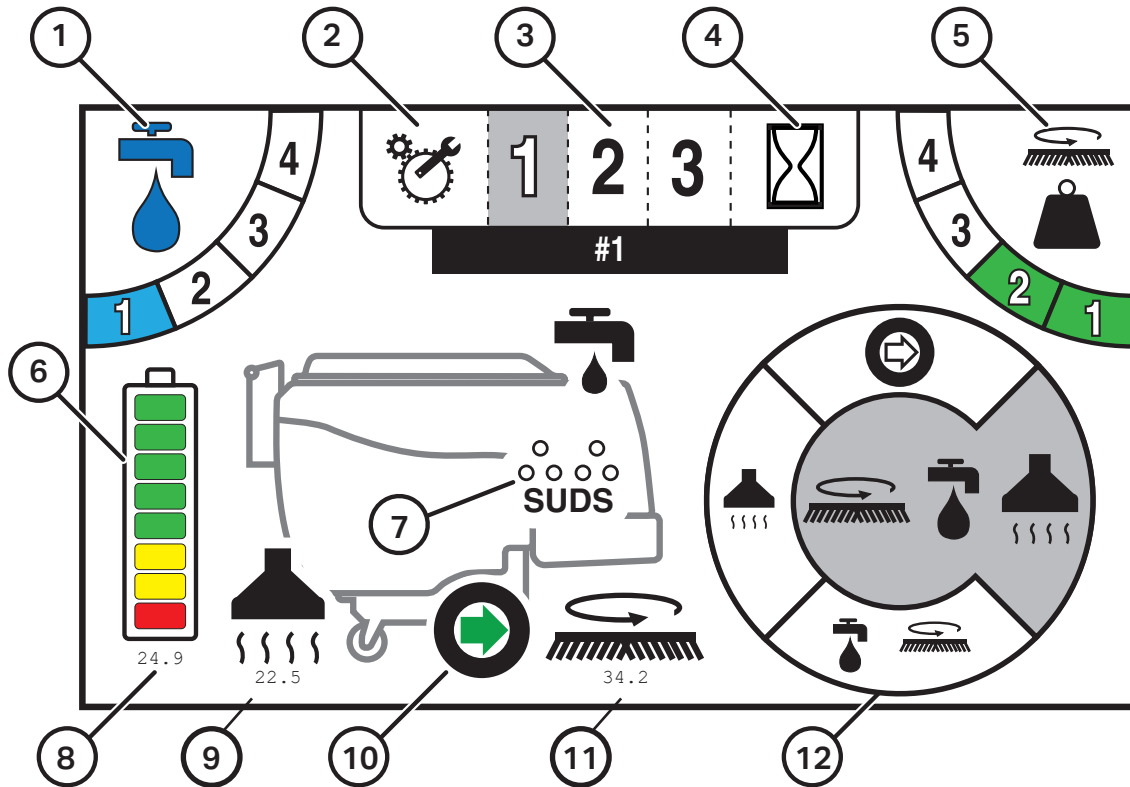
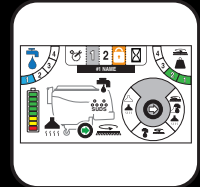

1. SOLUTION OUTPUT - Indicates the level of solution that is being dispensed when in operation, (0 = off, 1 = Low, 4 = High).
2. TECHNICAL / MANAGER SETUP - Access 'Error Code History' and Manager Programming
3. PROGRAMMED ZONES - Switch between preset solution and downpressure settings for varying applications
4. HOUR METERS - Displays all of the hour meters of the machine: Key Switch, Transport, Scrub Motors, and Vacuum Motor
5. DOWN PRESSURE OUTPUT - Indicates the level of downpressure that is being applied to the floor surface (1 = low, 4 = high).
6. BATTERY GAUGE - Indicates the level of battery charge available and volt meter
7. SUDS - (Onboard Chemical Dilution) indicator
8. ACTIVE VOLT & AMP DRAW - Indicates the live DC Volts (under battery gauge) and Amp draw (under systems) when machine is running
9. AMP VAC CURRENT - Indicates Vac power consumption
10. TRANSPORT INDICATION - Green Forward & Red Rev
11. BRUSH DISK CURRENT - Indicates Brush power consumption
12. OPERATION MODE SELECTOR - Cycle through and select which operation mode you would like to work in

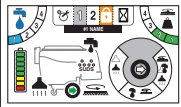

TOUCH SCREEN SYMBOLS (OPTIONAL)

Mode Selection

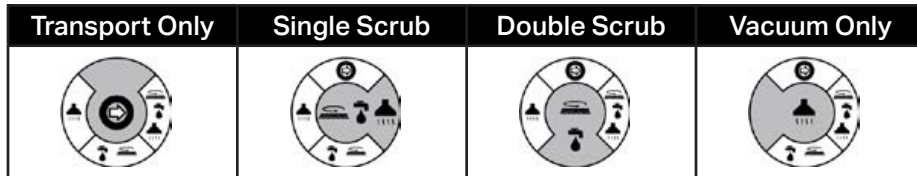

Solution Setting



Down Pressure Setting

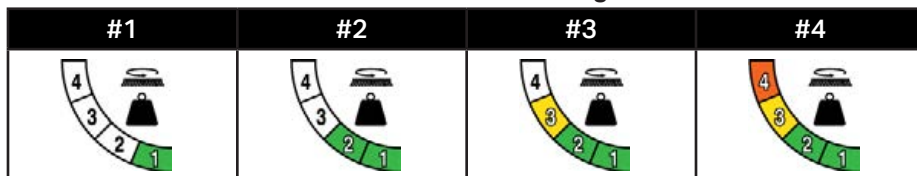

Forward Transport Motor

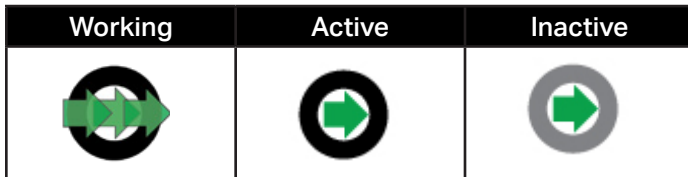

Reverse Transport Motor



Solution Flow

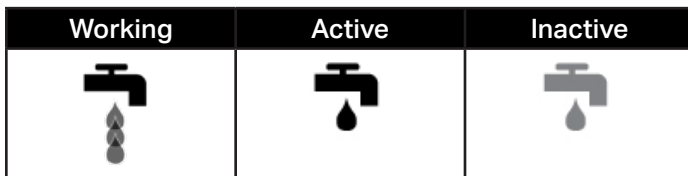

Vacuum Motor

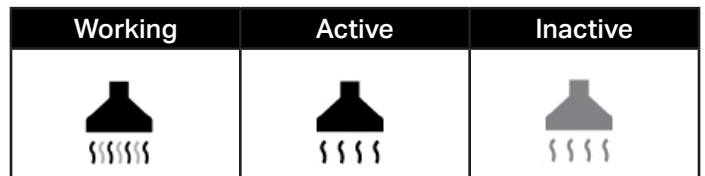

Suds

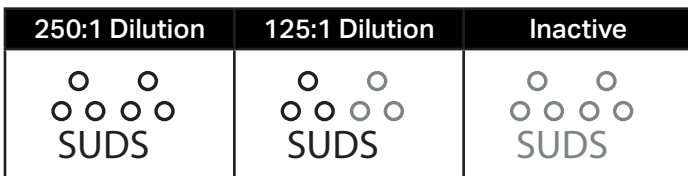

Scrub Deck Motor(s)

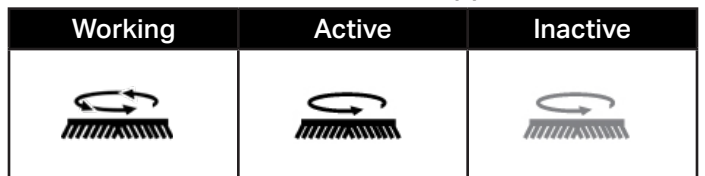

Setup



Hour Meters



Zone Lock

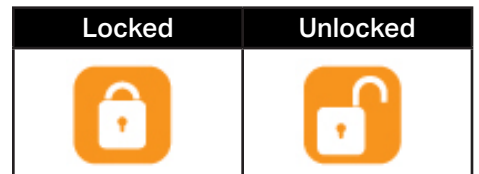

TOUCH SCREEN ZONE OPERATION (OPTIONAL)

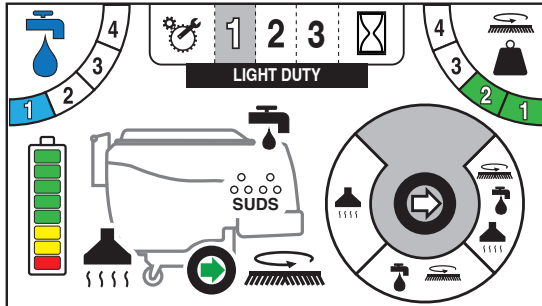
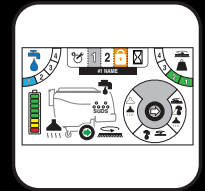

The touch screen is designed to be programmed to three specific zones. Each zone can be named and custom programmed or even disabled if not needed.

The zone you are working in is highlighted as indication. In Figure 1. the zone selected is Light Duty.

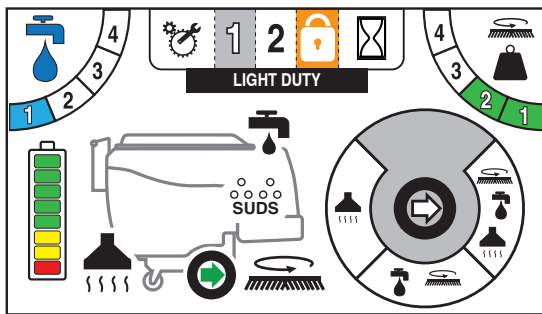

Figure 2. shows Zone 3 "locked out" by the indicator lock icon.

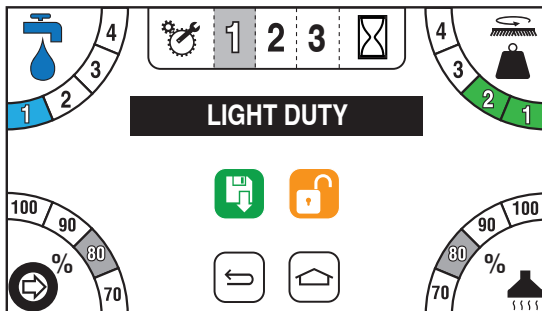

Figure 3. shows Zone 1 "Light Duty" Factory Configuration.

- Water = 1
- Downpressure = 2
- Drive Speed = 70%
- Vac Motor = 80%

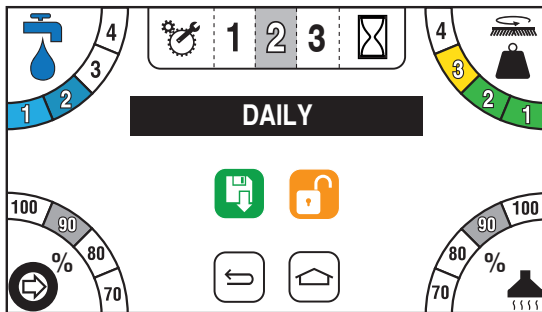

Figure 3. shows Zone 2 "Daily" Factory Configuration.

- Water = 2
- Downpressure = 3
- Drive Speed = 90%
- Vac Motor = 90%

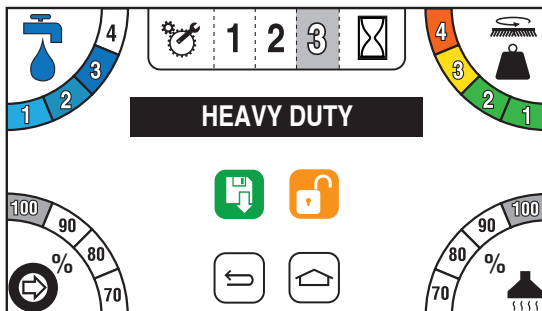
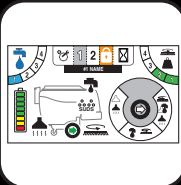
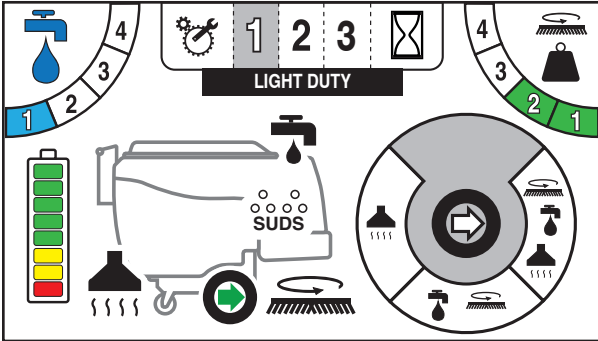

Figure 3. shows Zone 3 "Heavy Duty" Factory Configuration.

- Water = 3
- Downpressure = 4
- Drive Speed = 100%
- Vac Motor = 100%



TOUCH SCREEN ZONE PROGRAMMING (OPTIONAL)



To program the 3 Zones, press

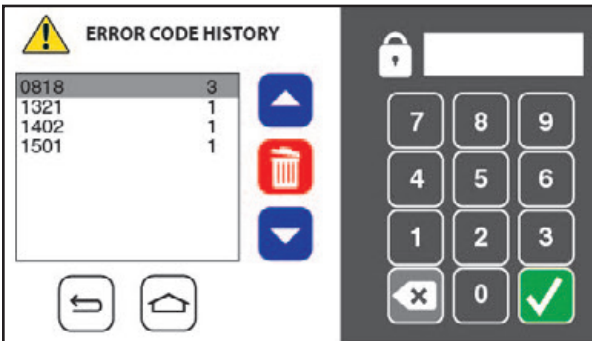

From here you will be prompted with a passcode screen. Enter the manager passcode 349 to get access to setup.



Once you have entered the password, you will see the Figure 3. screen where you can alter the name, solution output, down-pressure setting, scrubbing speed, and vacuum power.

Alternatively you can lock the Zone out from this screen, to prohibit operator use.

Once any of the 3 "Zones" is locked the remaining zones are no longer adjustable either by the operator.



To alter the name of a Zone, simply click on the black name box and a full keyboard will appear as Figure 4. shows. Enter new name and save your work with the Green save icon. 

MEMBRANE (MAG-HD ONLY)

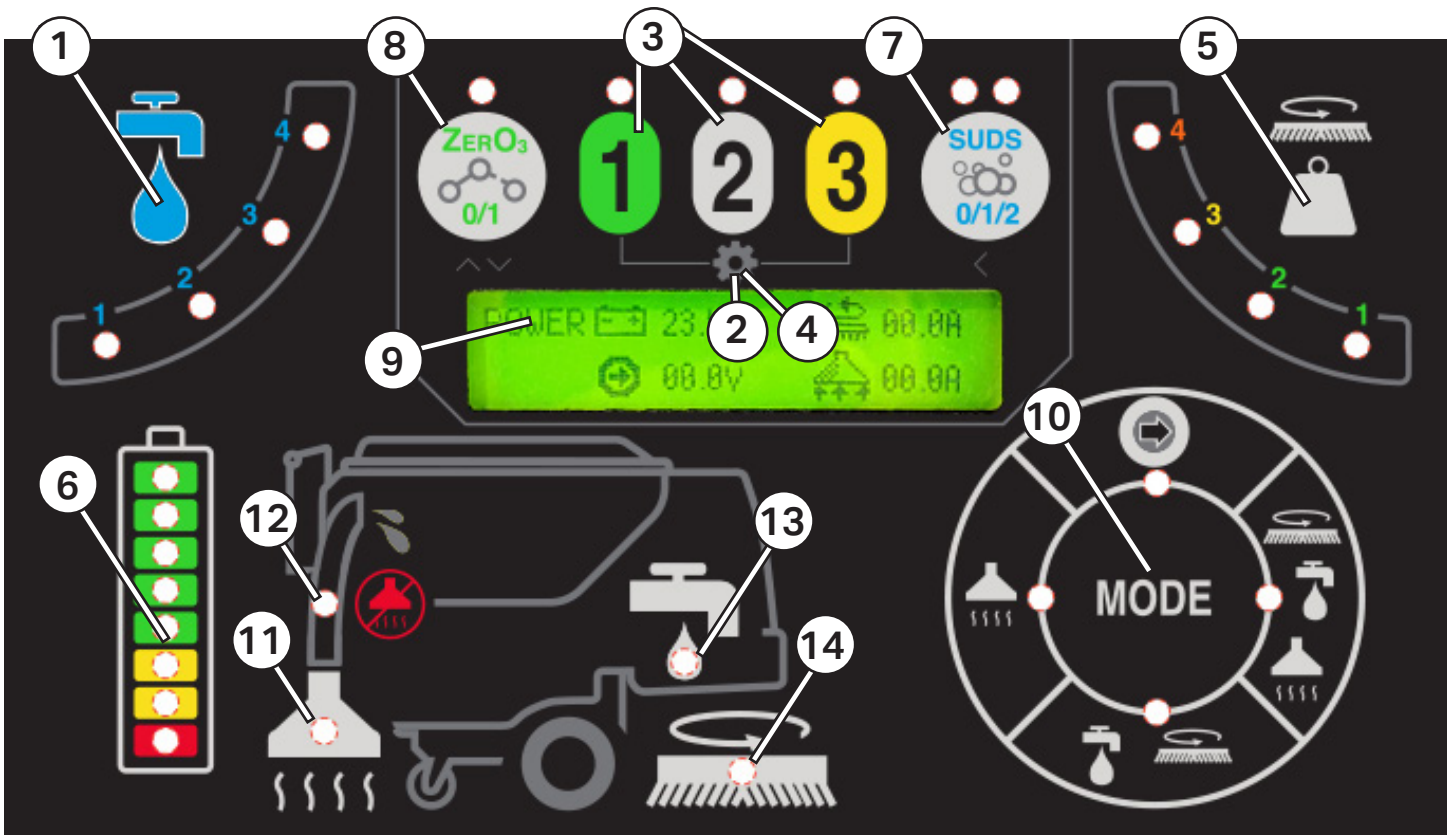
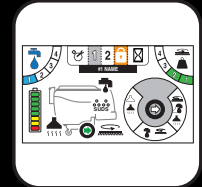

1. SOLUTION OUTPUT - Indicates the level of solution that is being dispensed when in operation, (0 = off, 1 = Low, 4 = High).
2. TECHNICAL / MANAGER SETUP - Access 'Error Code History' and Manager Programming (Press and Hold 1 & 3 for 5 seconds).
3. PROGRAMMED ZONES - Switch between preset solution and downpressure settings for varying applications
4. HOUR METERS - Displays all of the hour meters of the machine: Key Switch, Transport, Scrub Motors, and Vacuum Motor
5. DOWN PRESSURE OUTPUT - Indicates the level of downpressure that is being applied to the floor surface (1 = low, 4 = high).
6. BATTERY GAUGE - Indicates the level of battery charge available and volt meter
7. SUDS - (Onboard Chemical Dilution) indicator (OFF, Normal, 2x Dose)
8. ZER03 - (Chemical Free Auquous Ozone) indicator
9. ACTIVE VOLT & AMP DRAW - Indicates the live DC Volts (under battery gauge) and Amp draw (under systems) when machine is running
10. OPERATION MODE SELECTOR - Cycle through and select which operation mode you would like to work in
11. VAC LIGHT- Indicates when vacuum is on
12. VAC CLOG LIGHT- Indicates when vacuum is clogged
13. SOLUTION LIGHT- Indicates active solution to scrub deck
14. SCRUB DECK LIGHT- Indicates active scrub deck



Mode Wheel

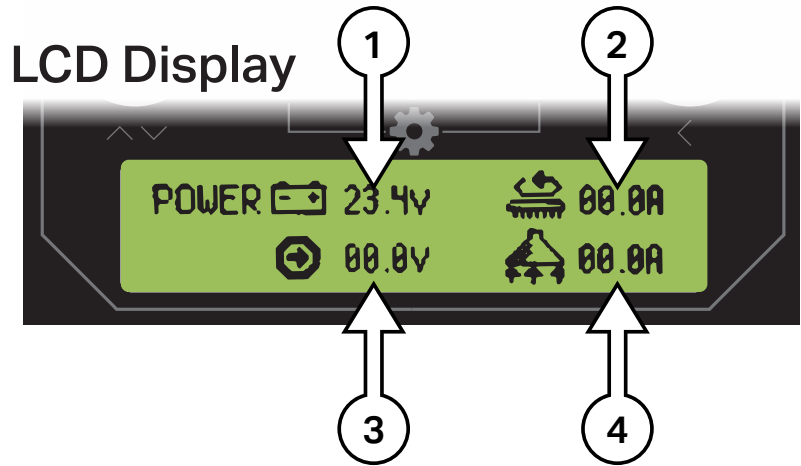
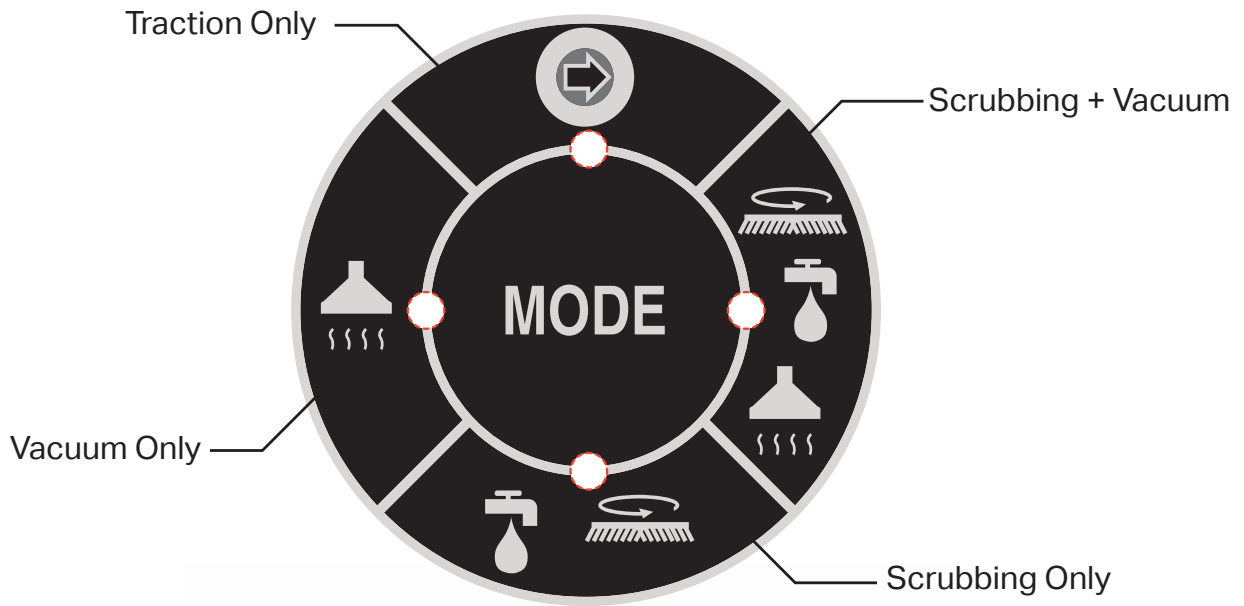

1. BATTERY VOLTAGE READOUT
2. SCRUBDECK AMPERAGE READOUT
3. TRACTION VOLTAGE READOUT
4. VACUUM AMPERAGE READOUT



Programming Zones

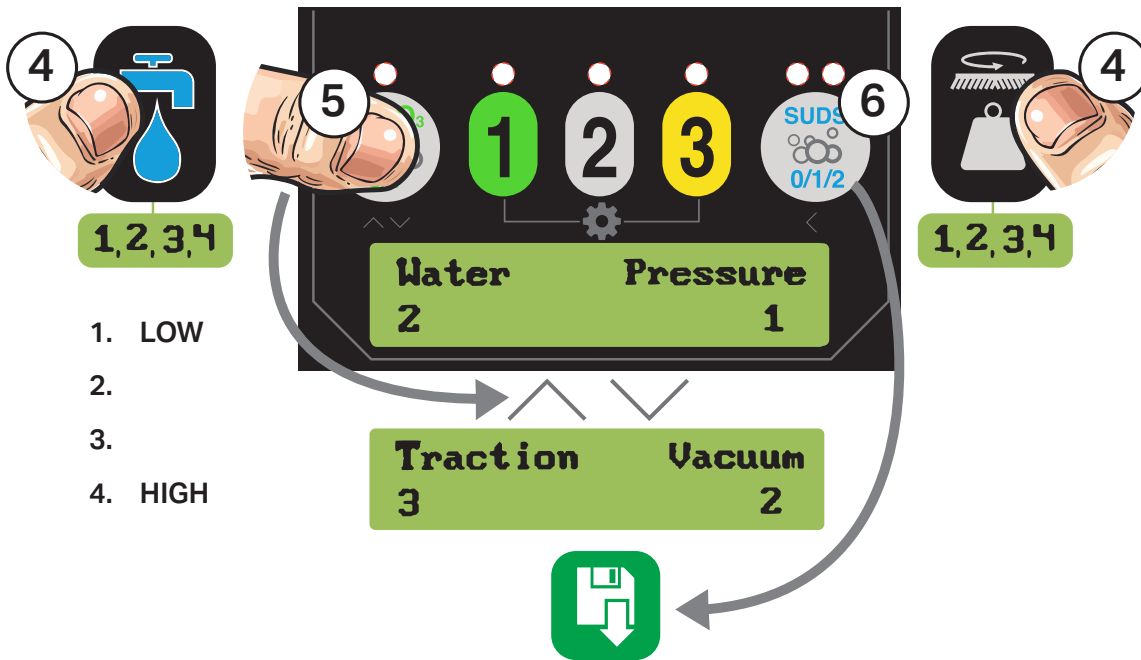
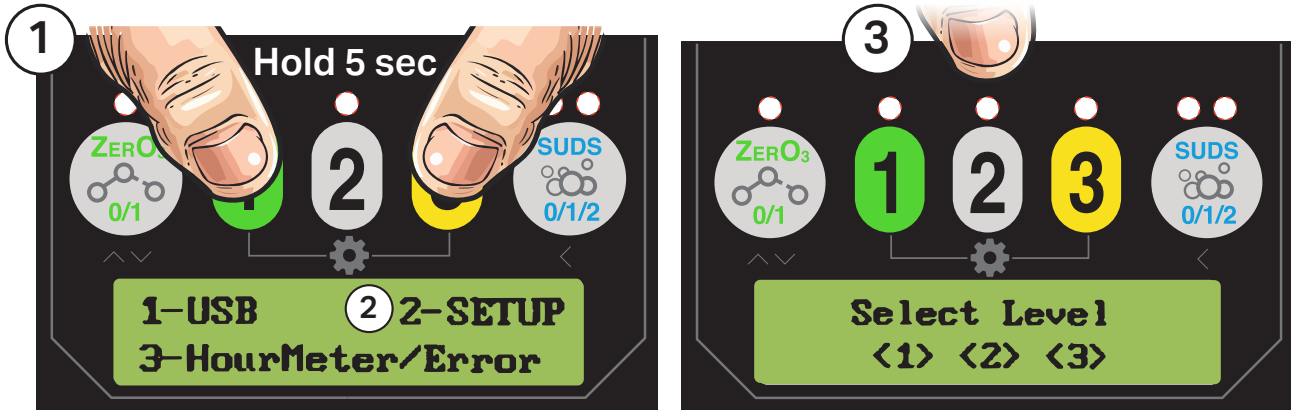

- 1. LOW
- 2.
- 3.
- 4. HIGH

- ① HOLD (1) & (3) FOR 5 SEC
- ② SELECT SETUP (2)
- ③ SELECT LEVEL
- ④ WATER/DOWNPRESSURE CHANGES VALUES
- ⑤ PUSH ZERO3 TO SWAP SCREENS
- ⑥ PUSH SUDS TO SAVE

Operator Video



MEMBRANE (MAG-HD ONLY)



Checking Hour Meters & Error Codes

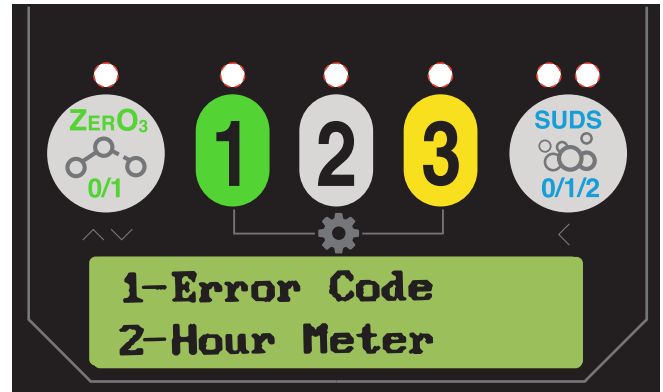
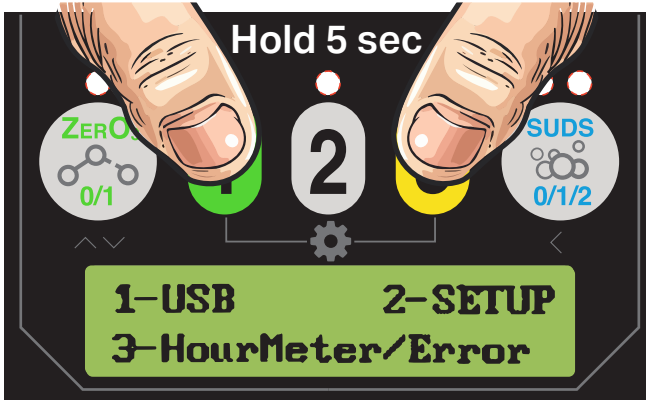

Select (3)

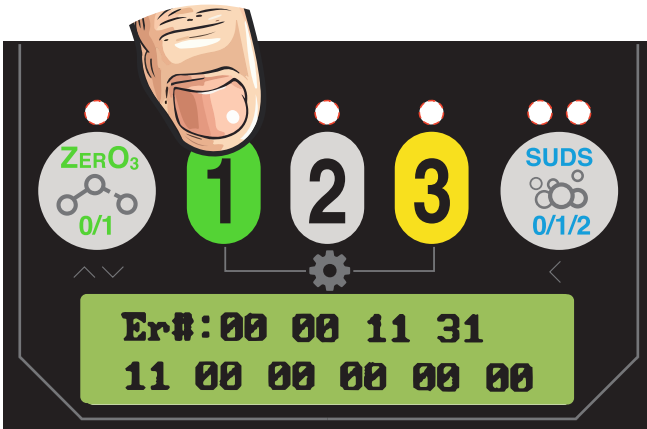

Membrane Zones Factory Default

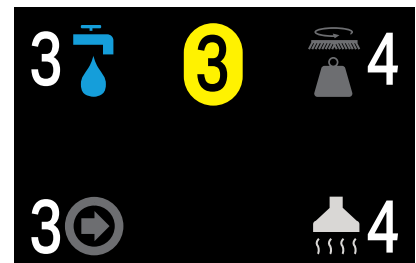

BATTERY SETUP

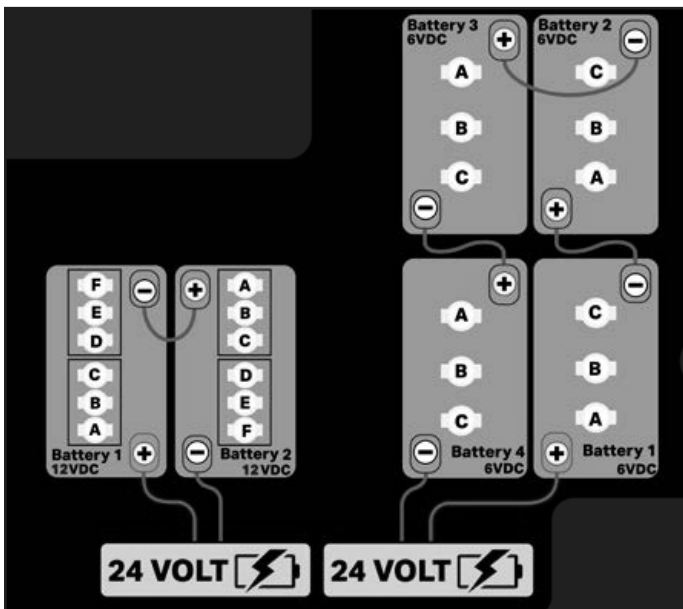
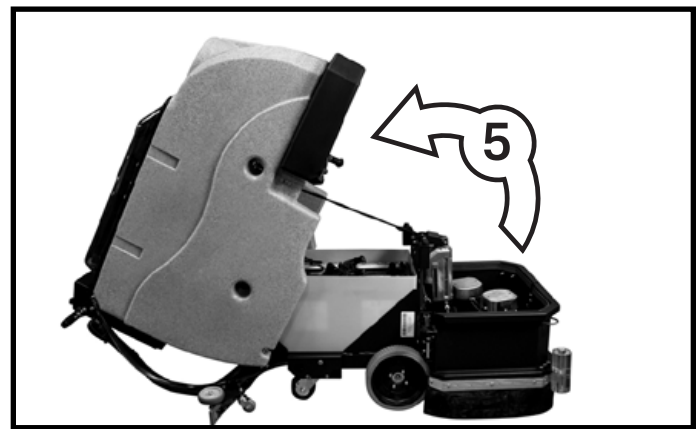
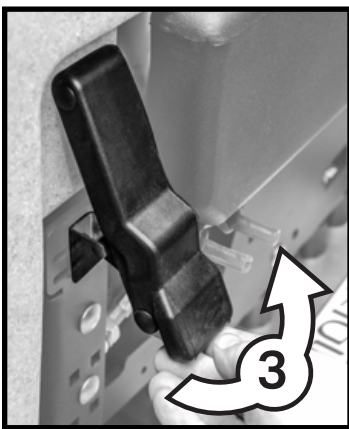
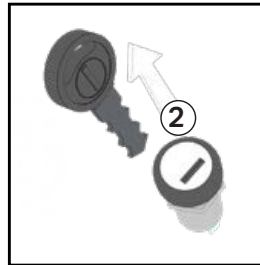
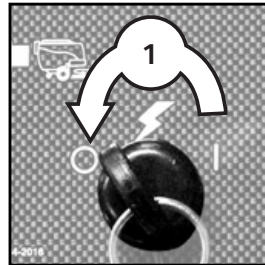
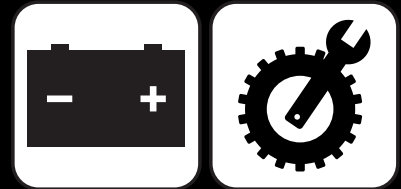

NOTICE
Batteries are a possible environmental hazard. Consult your Battery supplier for safe disposal methods.

NOTICE
Orientation of Batteries is critical for cables to reach. Ensure proper torque values when installing batteries. (Between 8 - 12 ft/lbs)



INSTALL SQUEEGEE

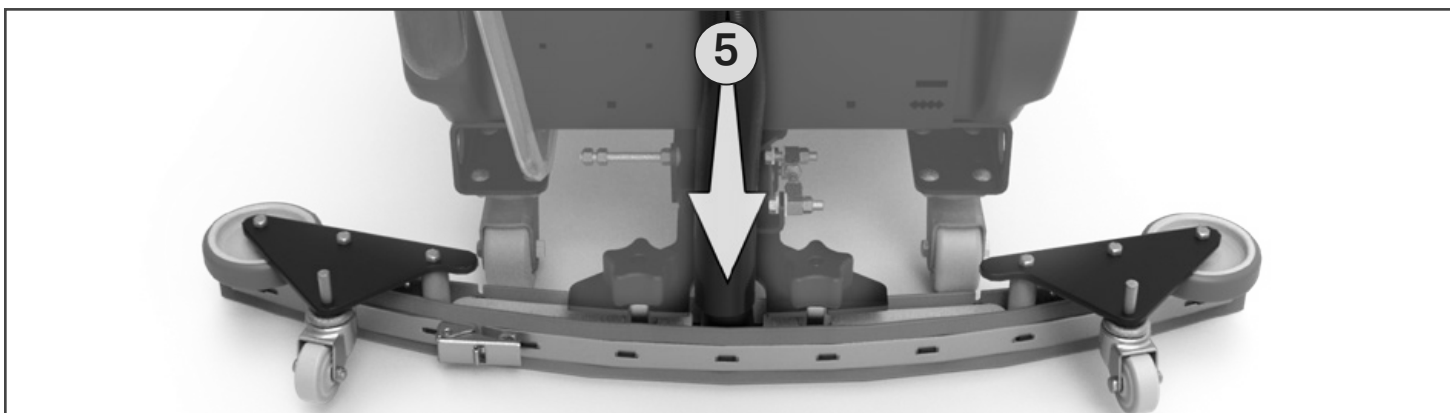
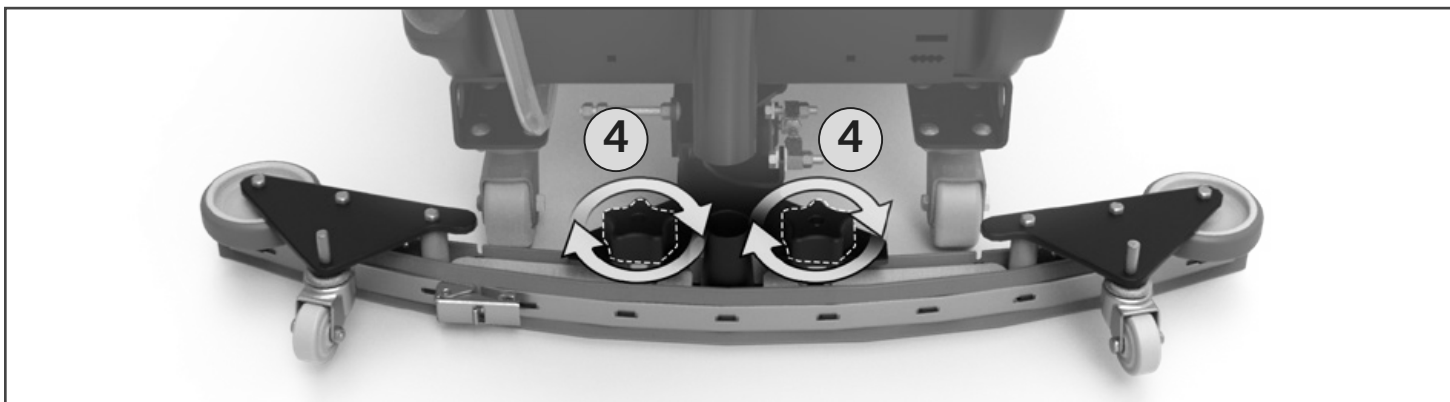
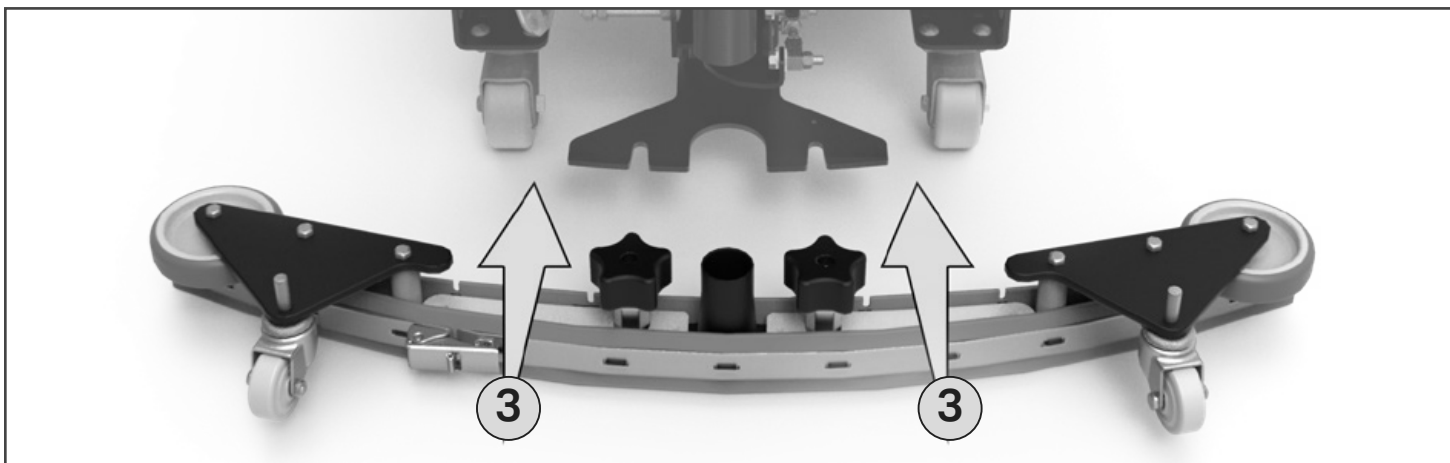
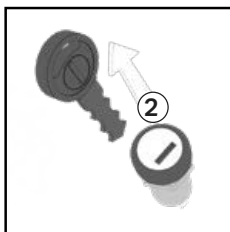
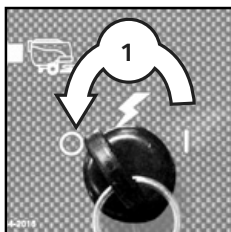

ADJUST SQUEEGEE

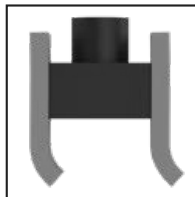
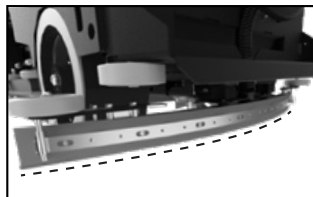
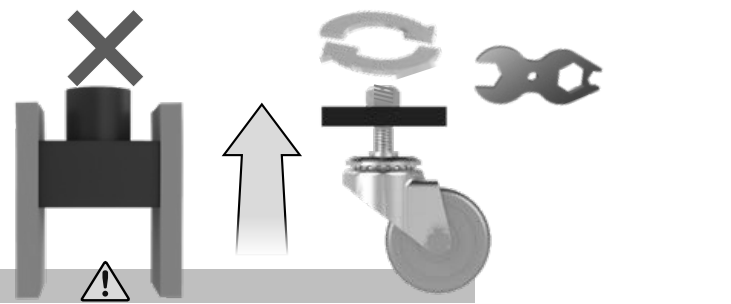
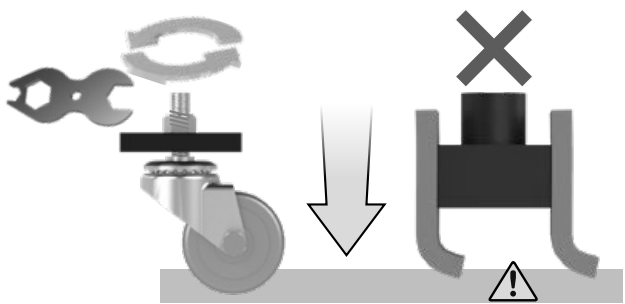
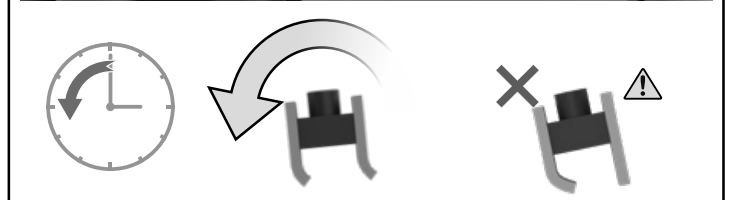
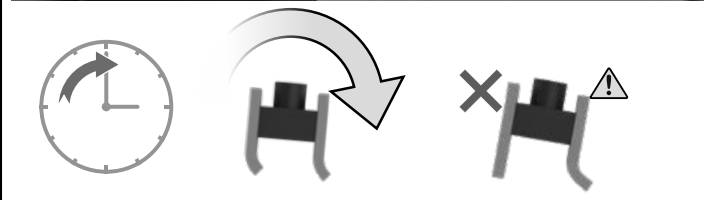
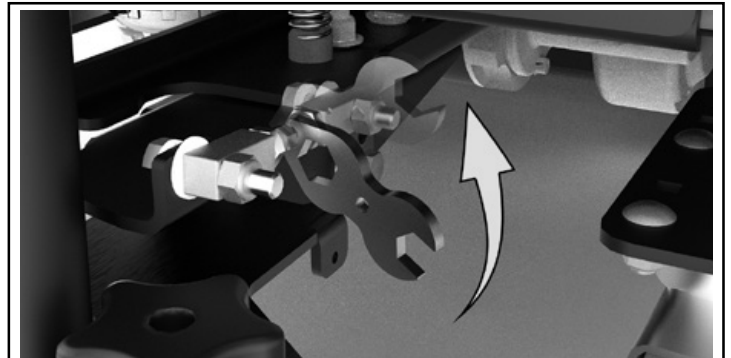
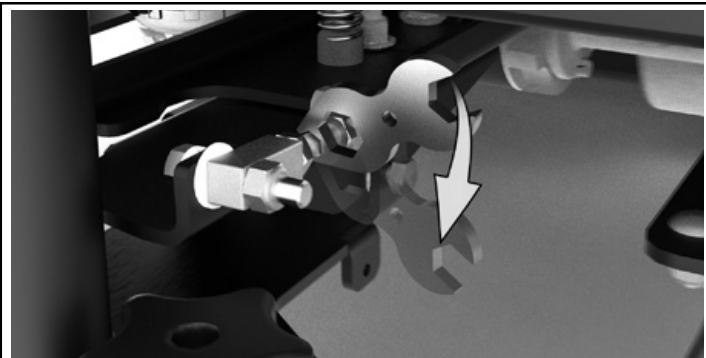
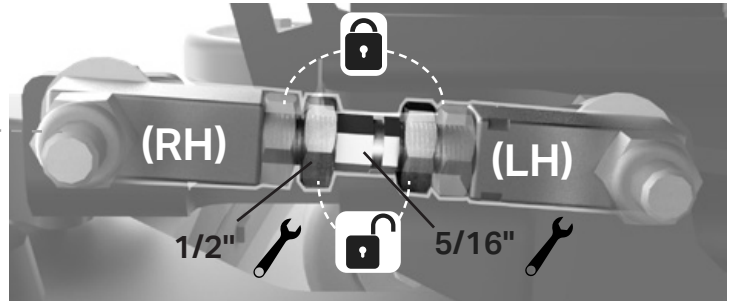
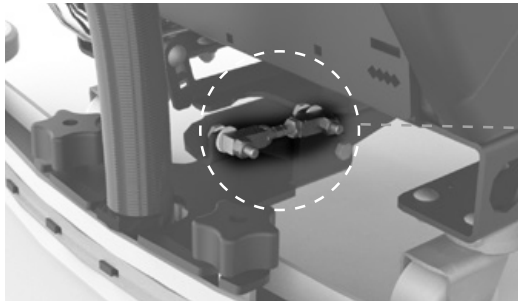
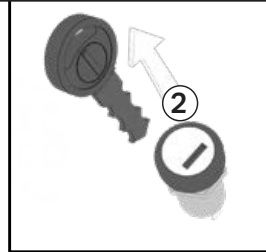
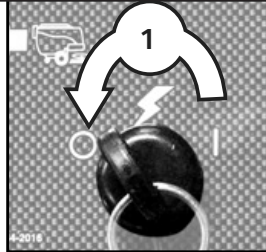

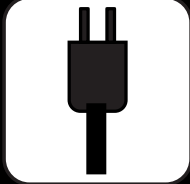
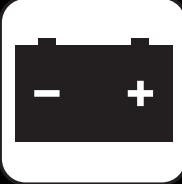

REMOVE FROM BATTERY CHARGER

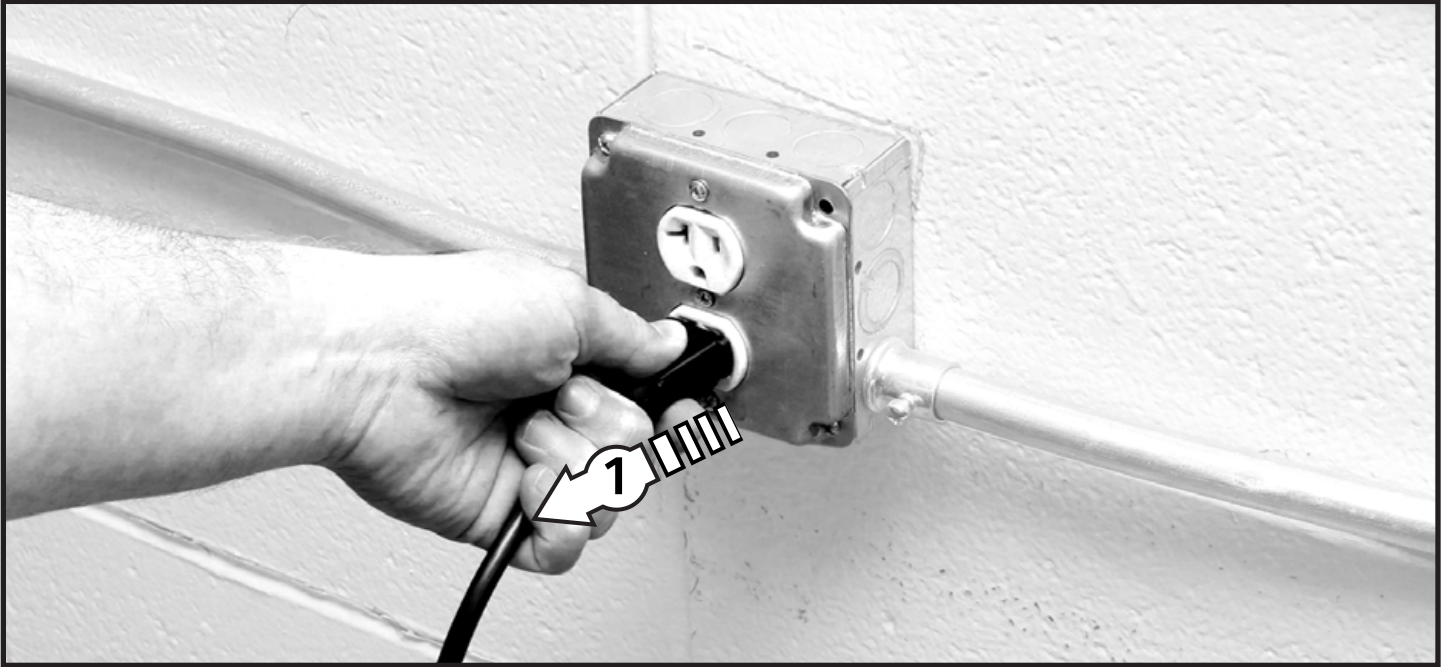

Please refer to OEM Charger Operating Instructions for more information.

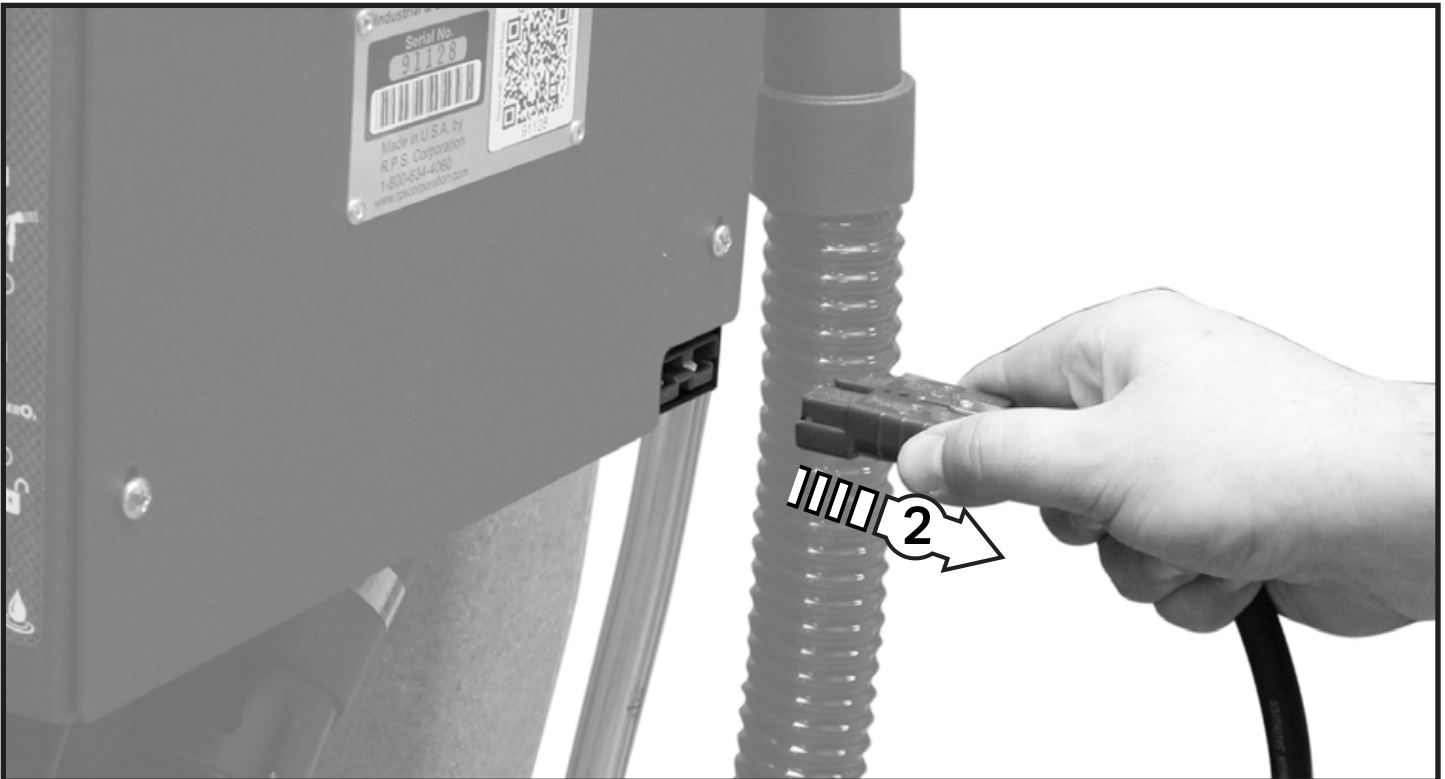



Military Grade

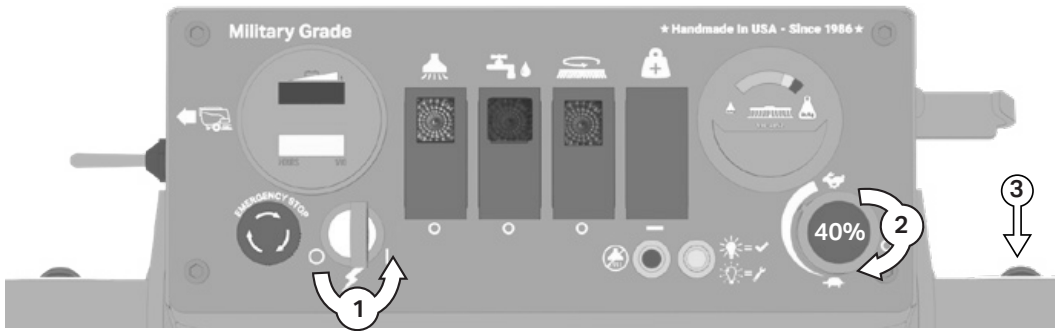

Legacy

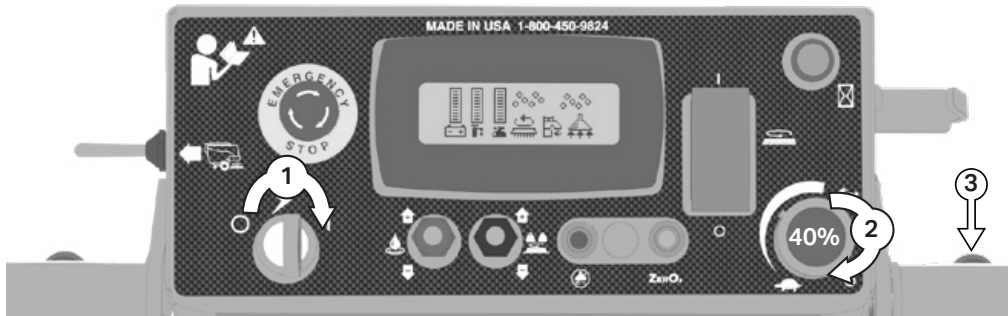

Touch Screen

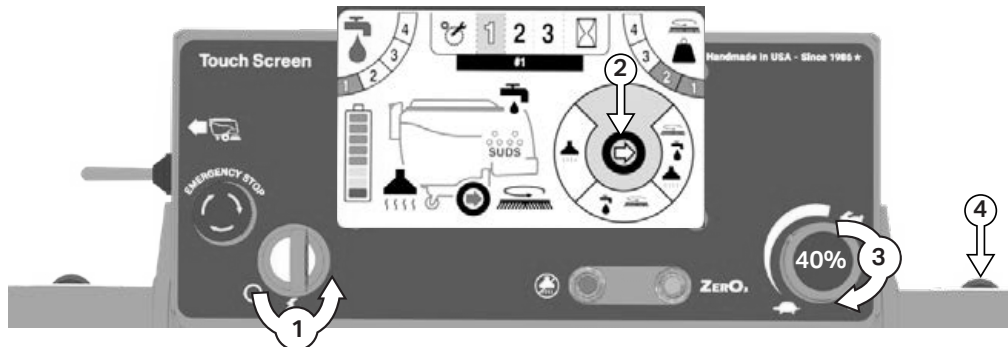

Membrane (Mag-HD)





TRANSPORTATION - REVERSE

Military Grade

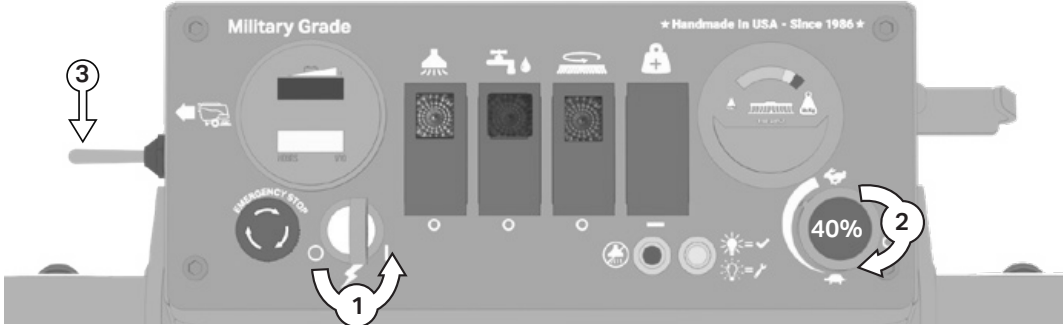

Legacy (MICRO-HD/MINI-HD)

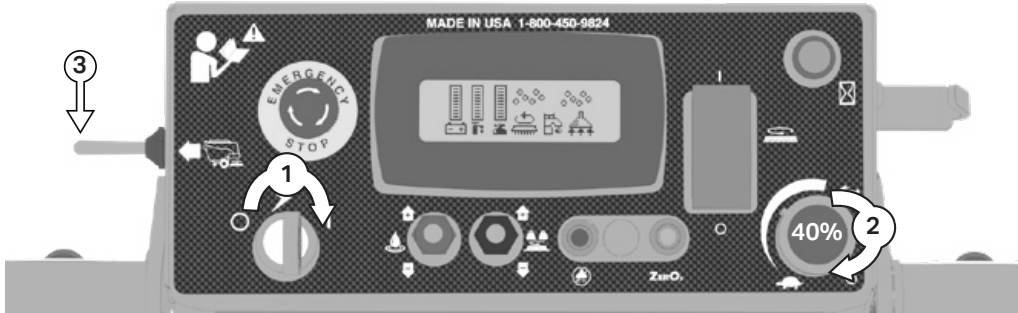

Touch Screen

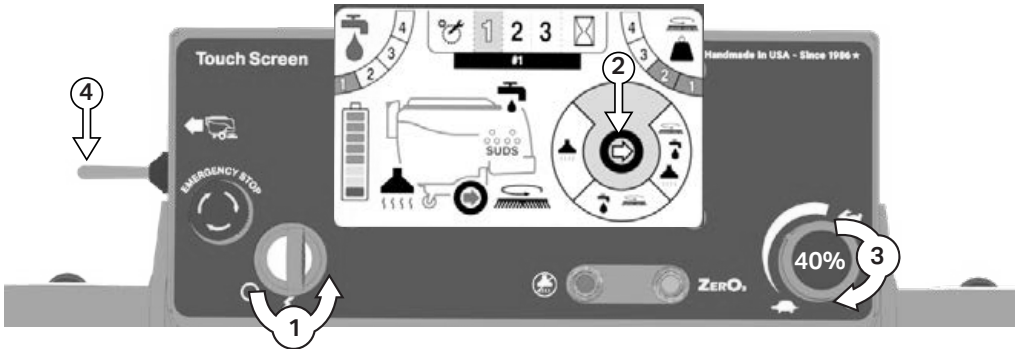

Membrane (Mag-HD)

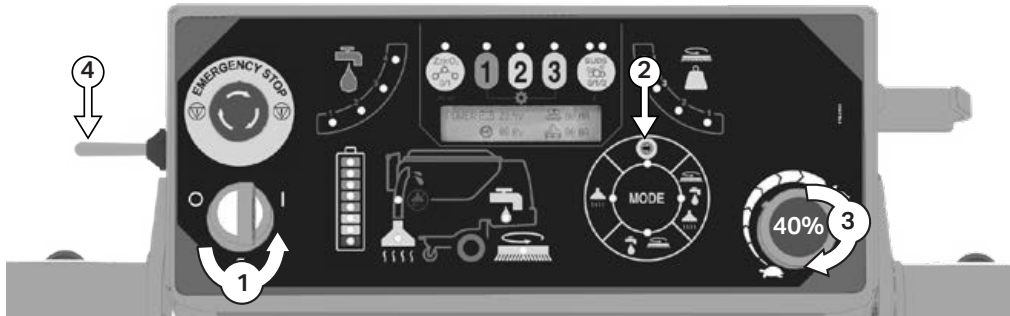

FILL SOLUTION TANK



⚠ DANGER

EXPLOSION RISK! Flammable materials can cause an explosion or fire. Do NOT use flammable materials in Tank or pick up.

⚠ CAUTION

TO AVOID DAMAGE TO THIS MACHINE:

- Use APPROVED detergents only
- Water temperature must not exceed 135 °F/57 °C
- Do NOT use high-percentage Bleach mixture

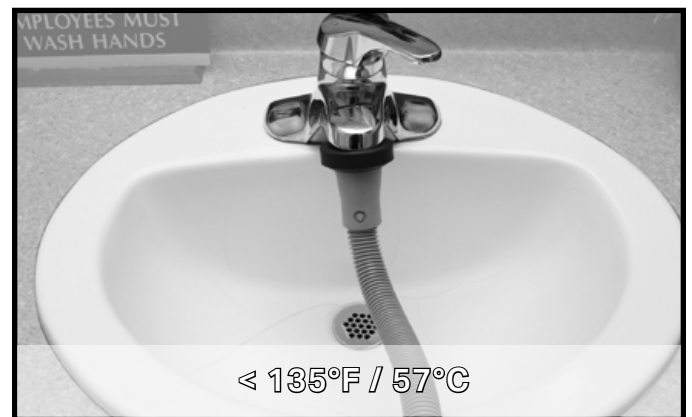
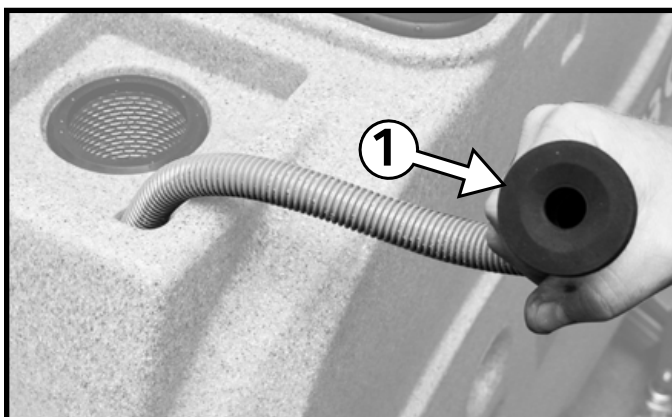



OPERATION - SCRUBBING

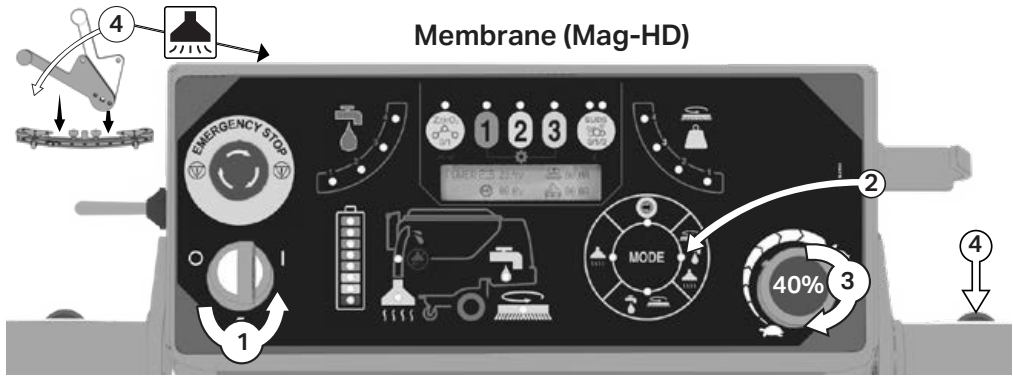
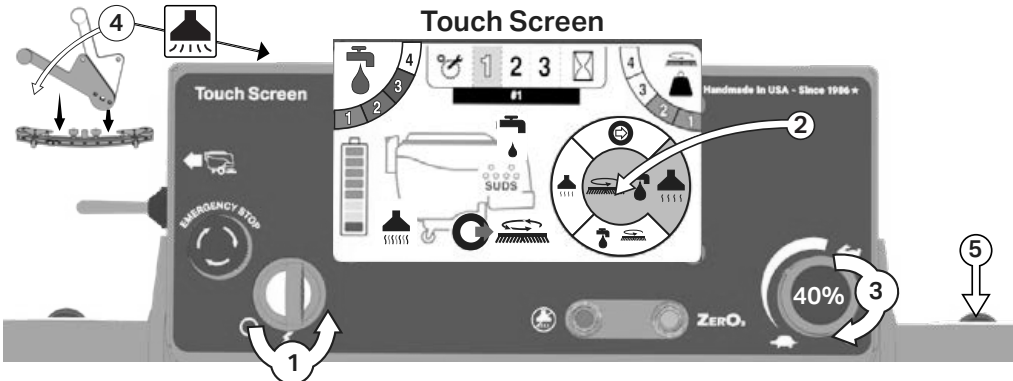
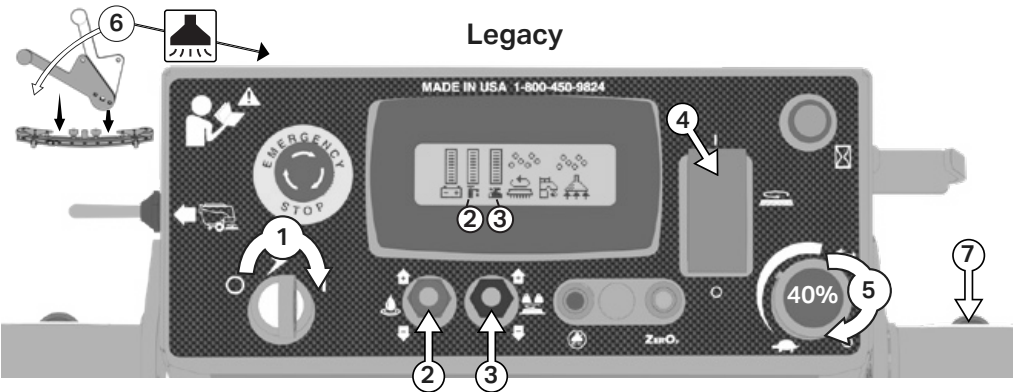
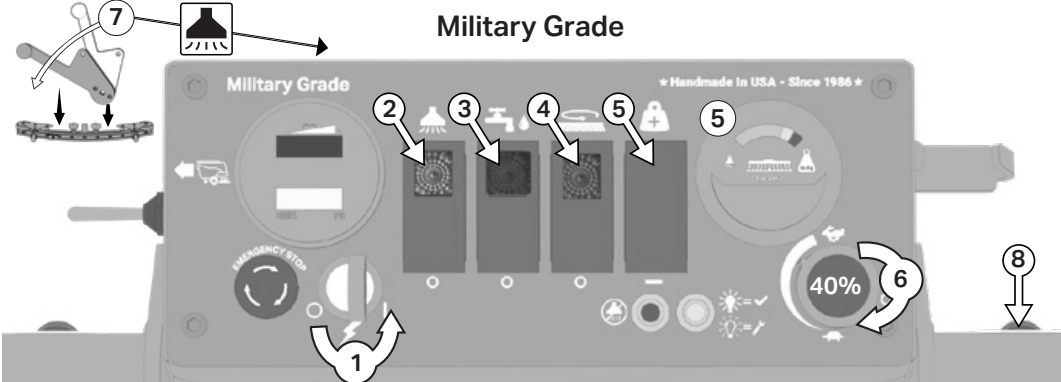

DRAINING RECOVERY TANK

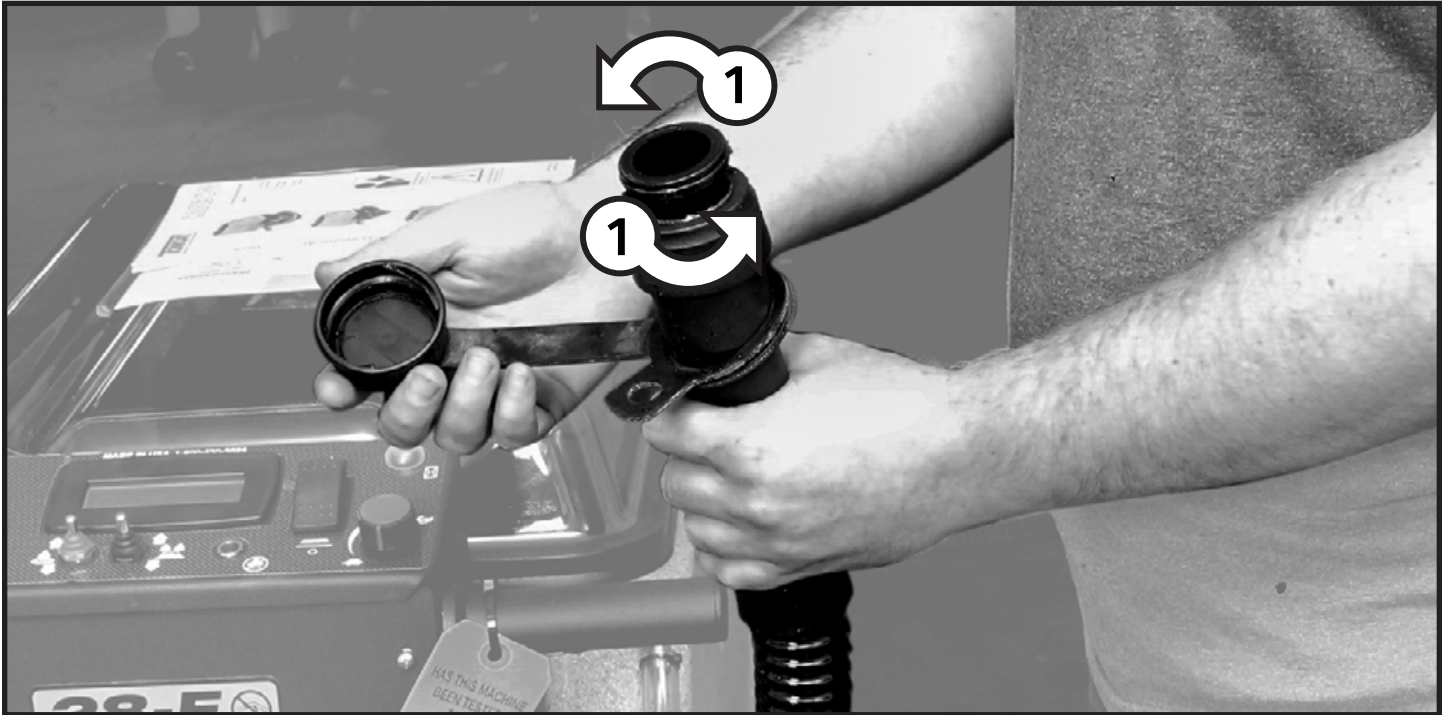
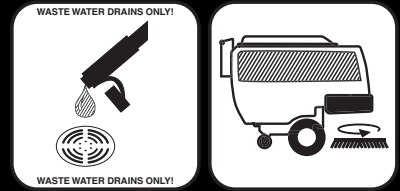



DRAINING SOLUTION TANK

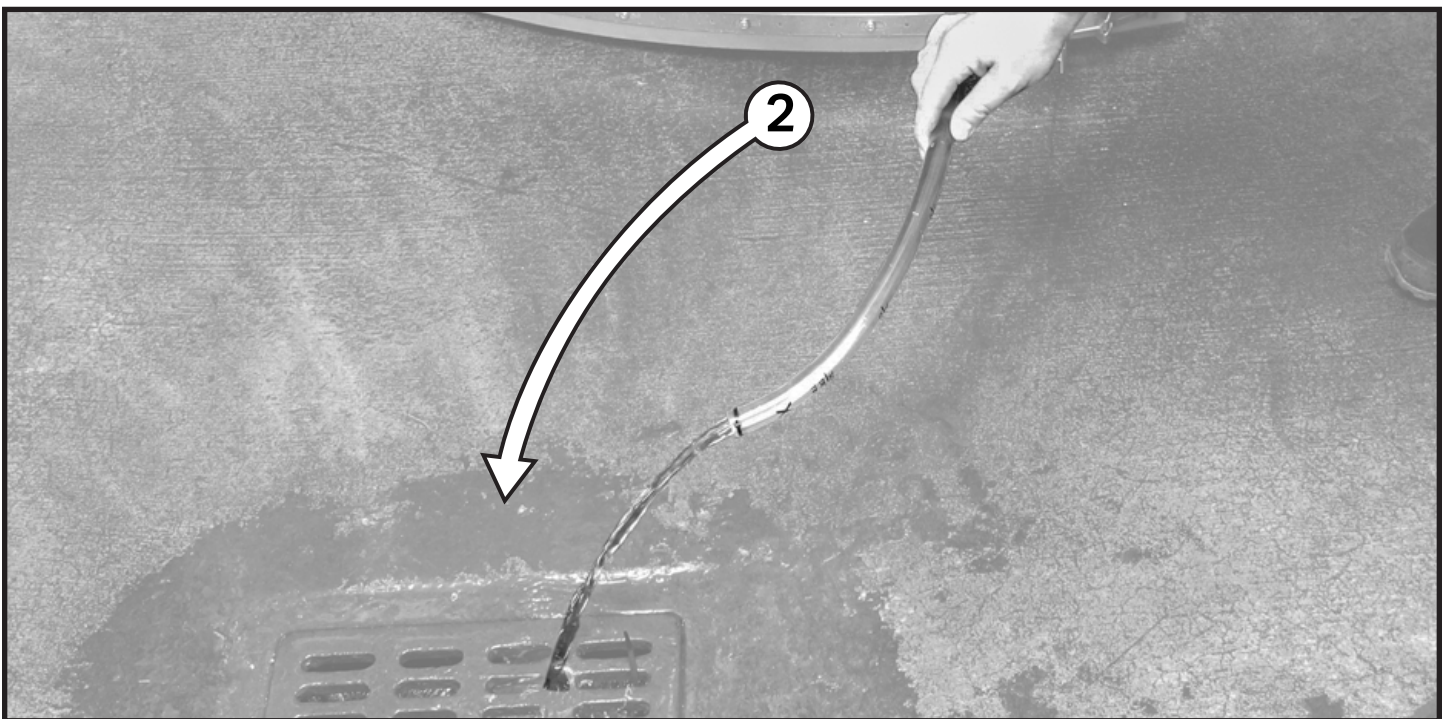
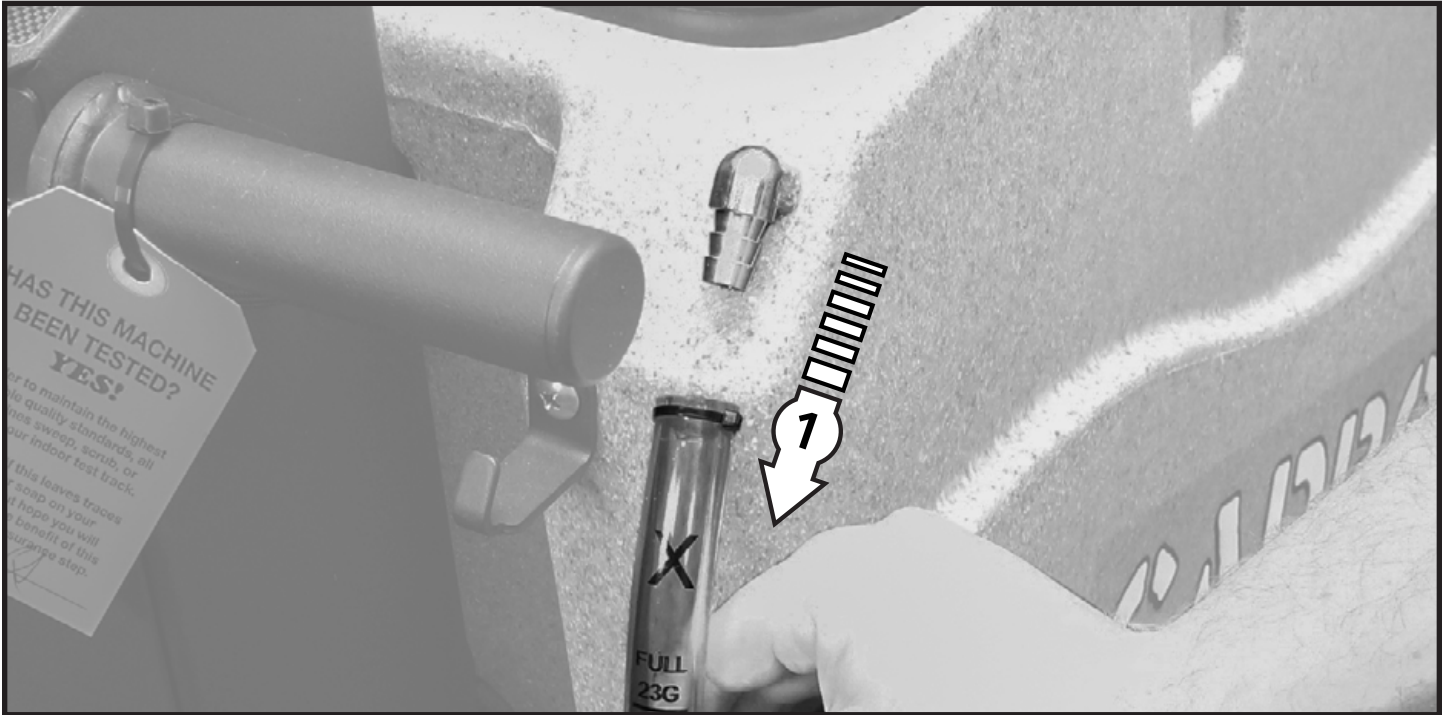

FLUSHING RECOVERY TANK

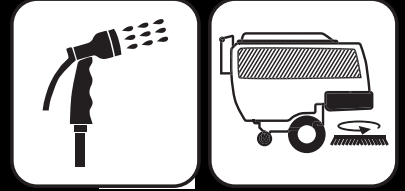



CLEAN DRAIN SAVER

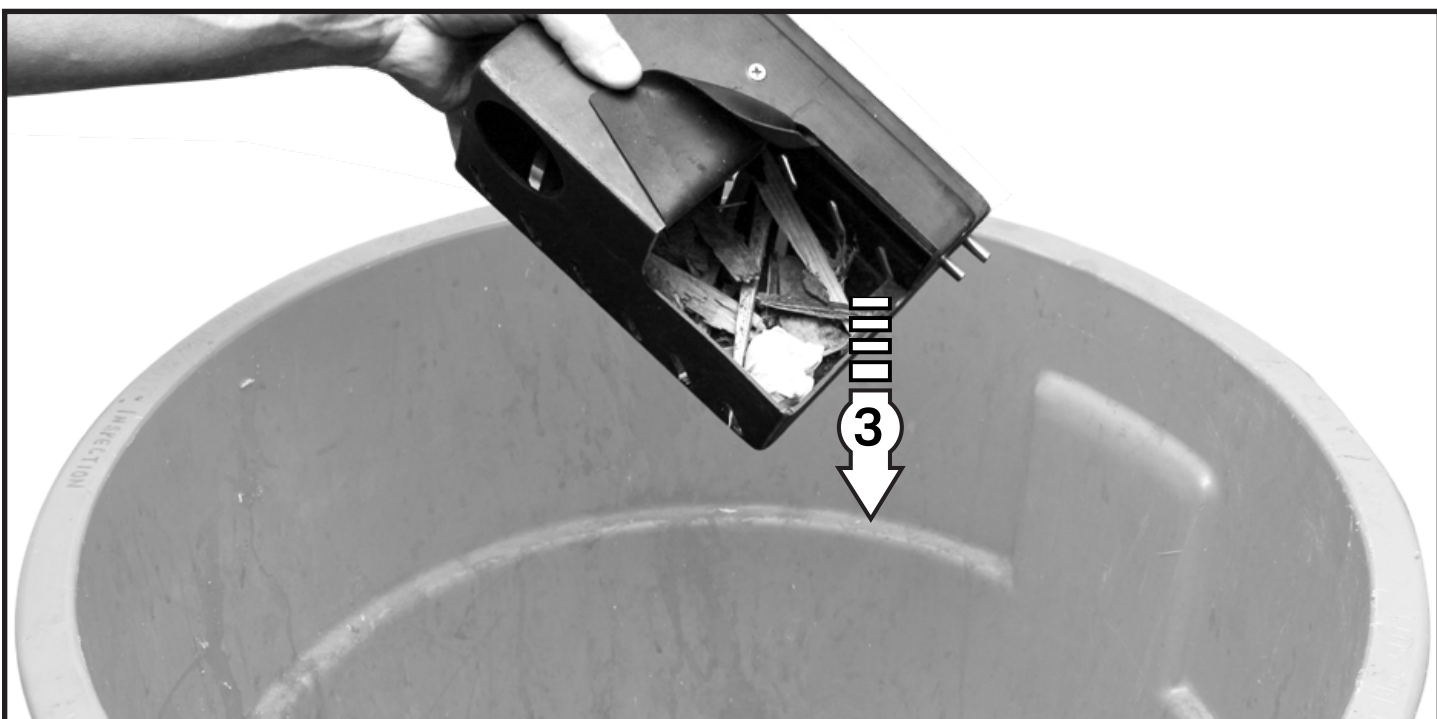
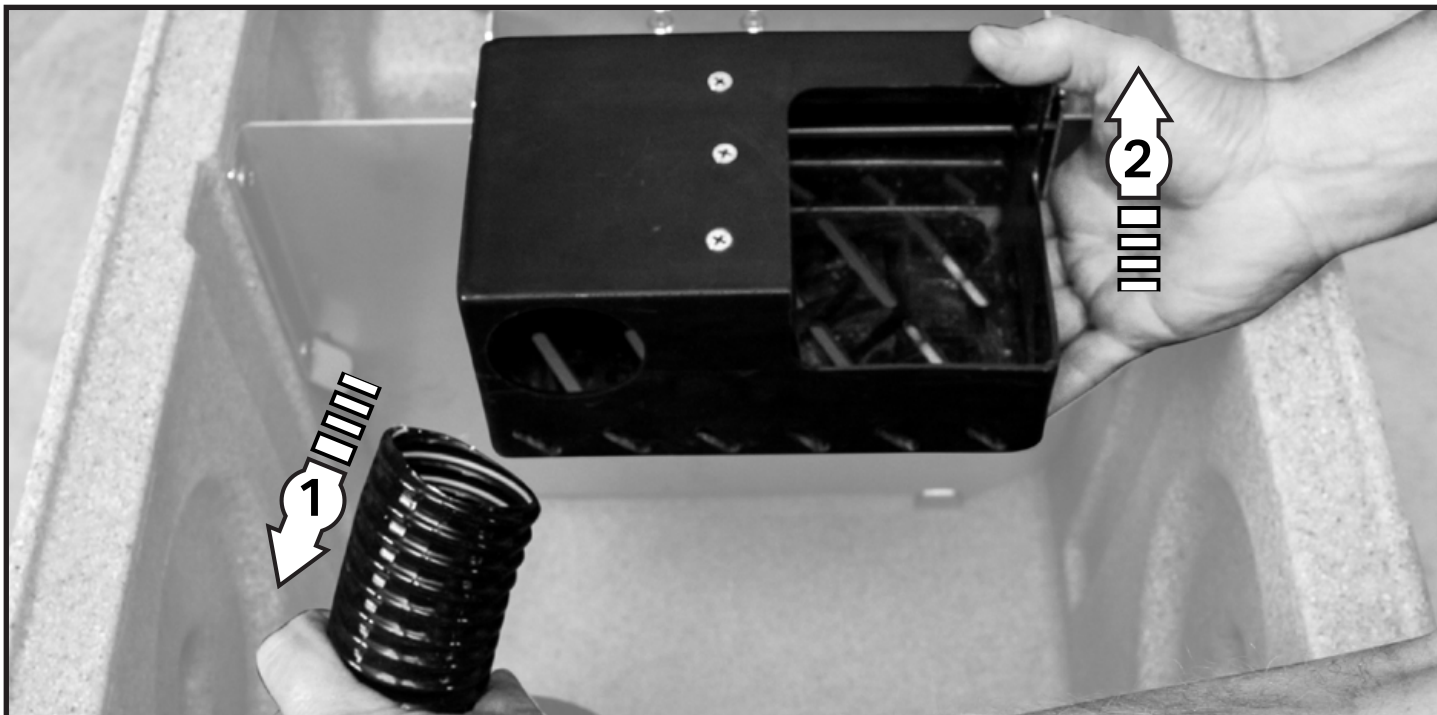

CLEAN CYLINDRICAL HOPPER

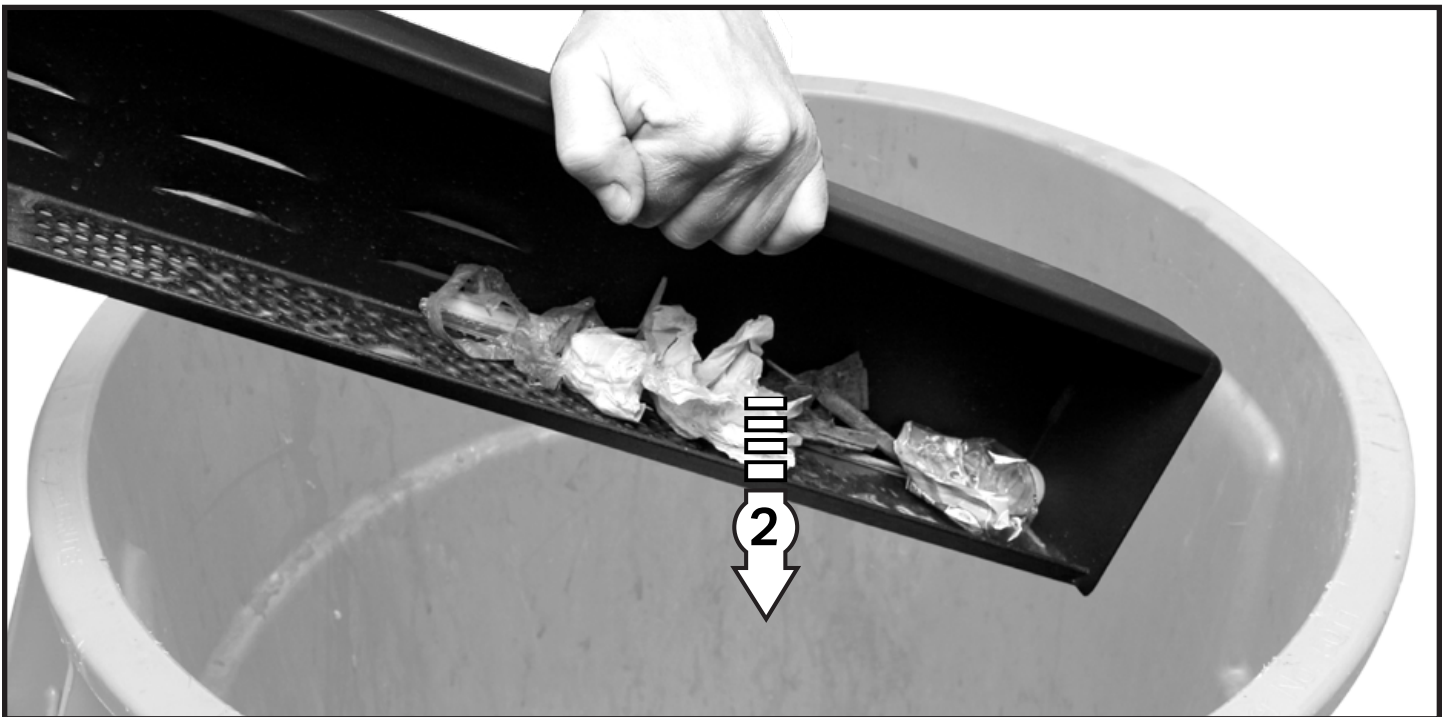
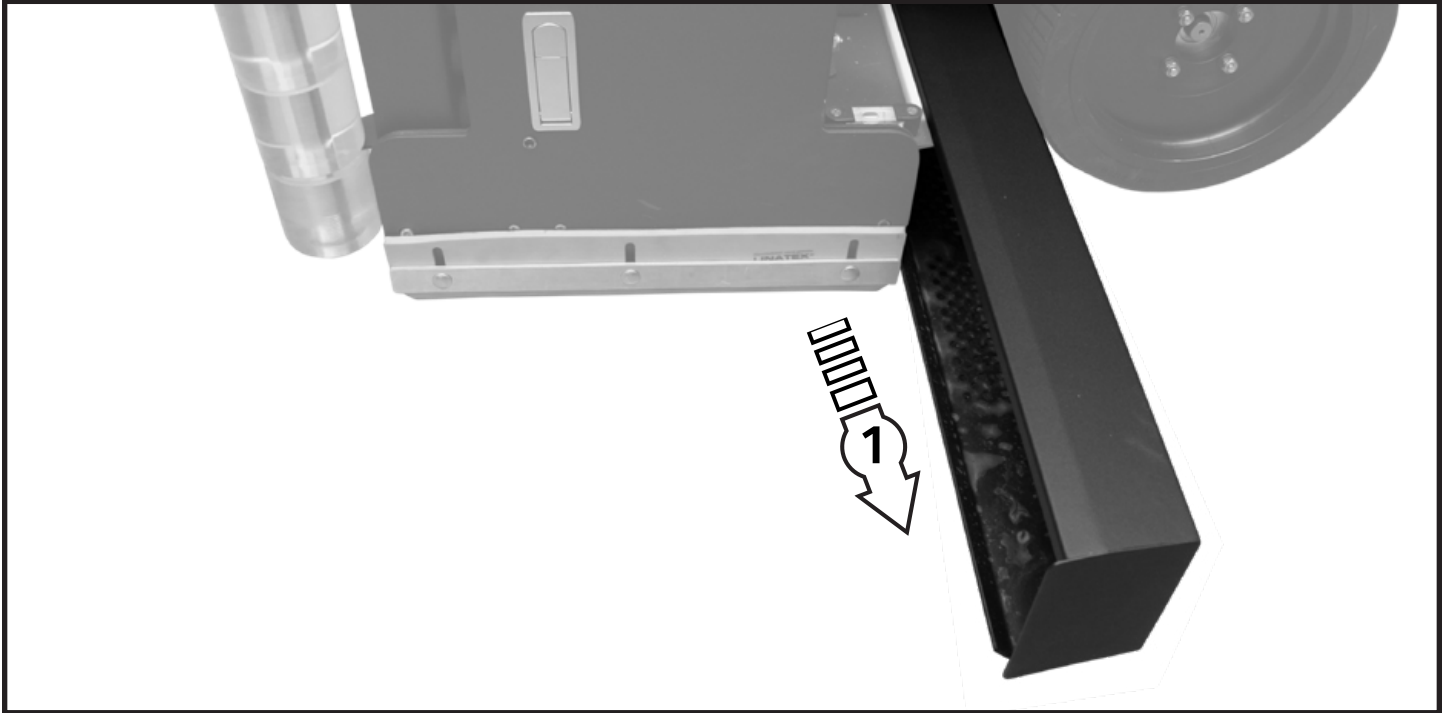



CLEAN VAC BOX SYSTEM

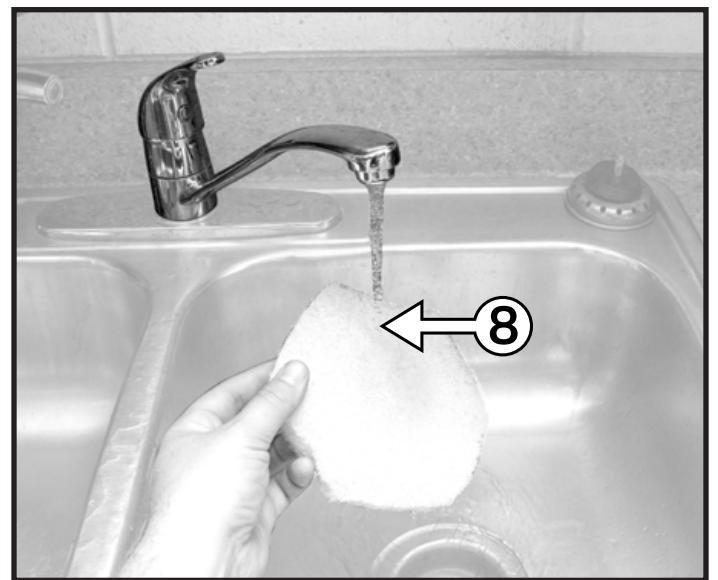
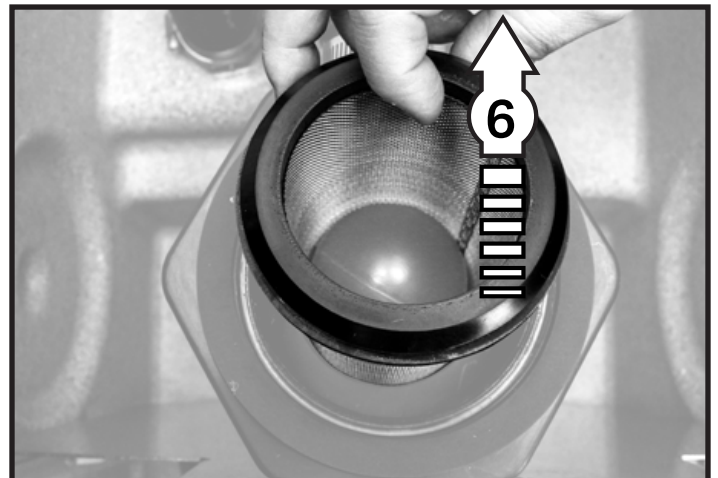
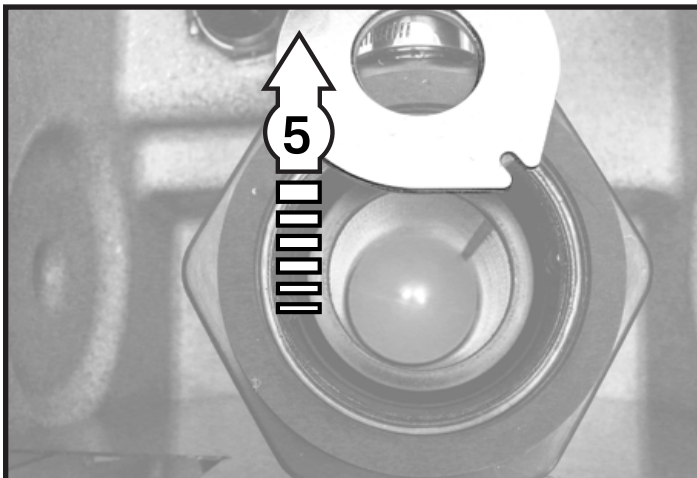
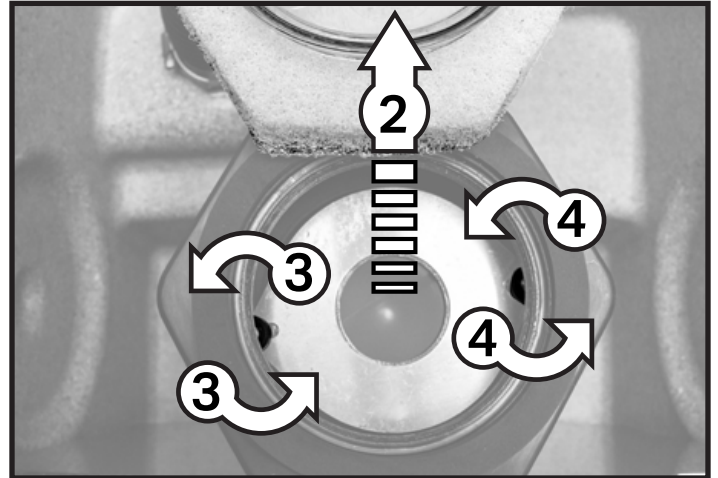
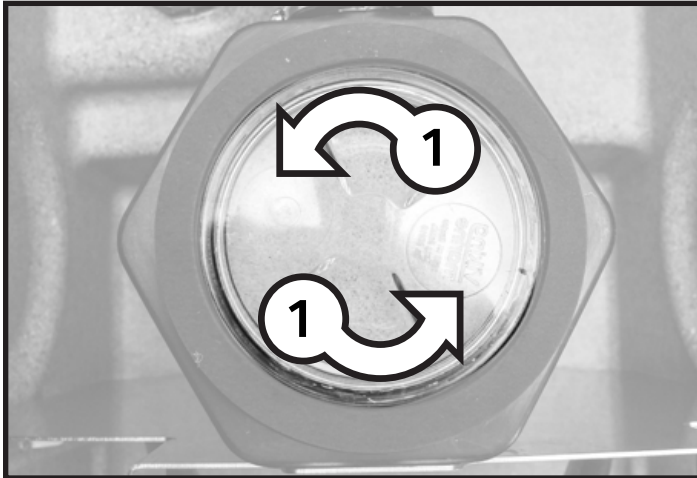

REMOVE DISK BRUSHES

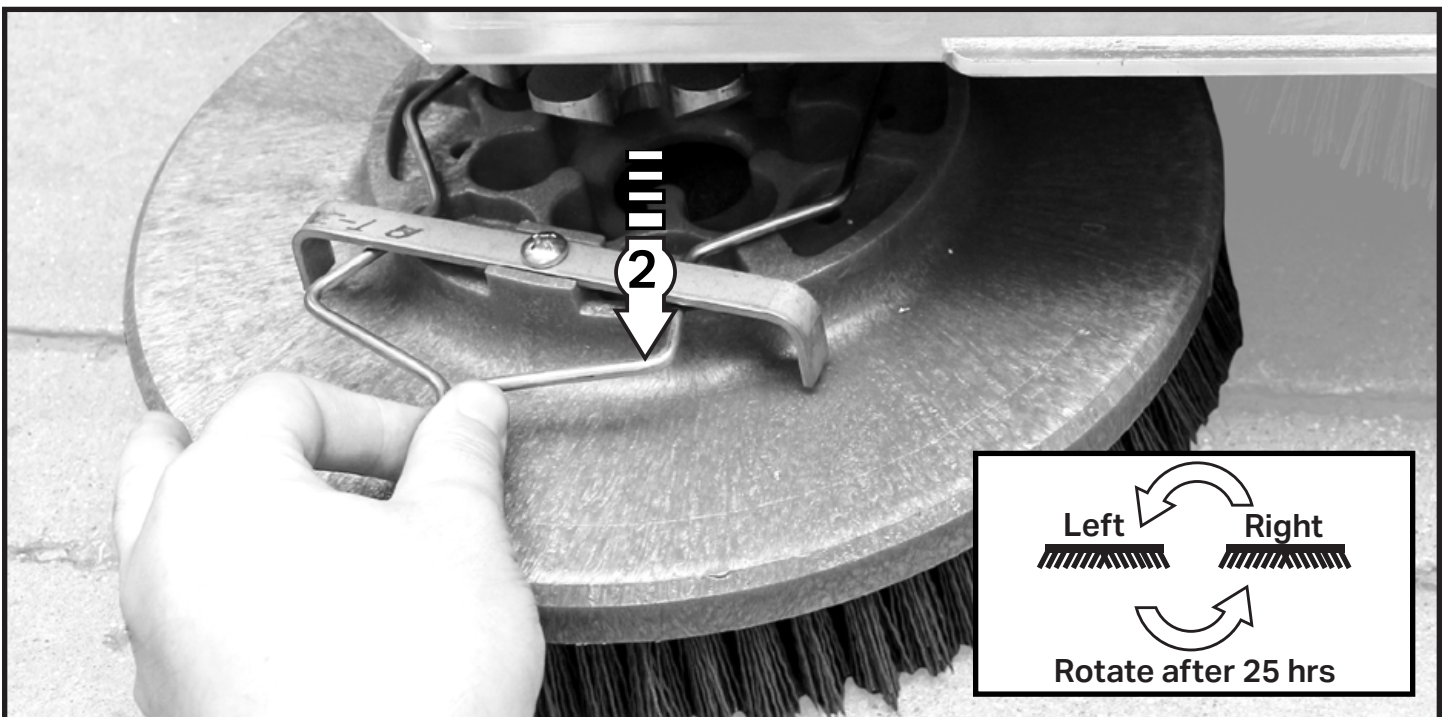

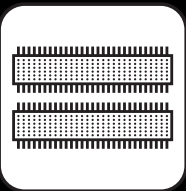

REMOVE CYLINDRICAL BRUSHES

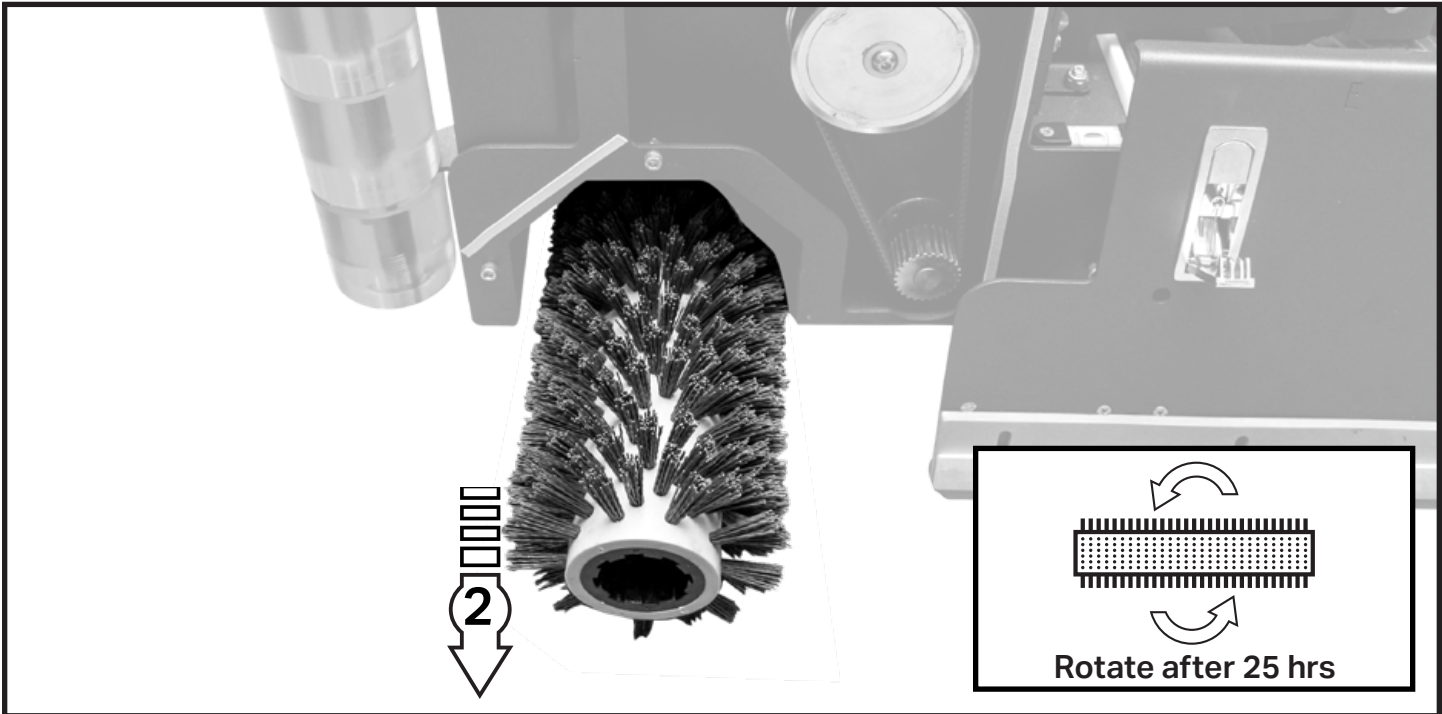
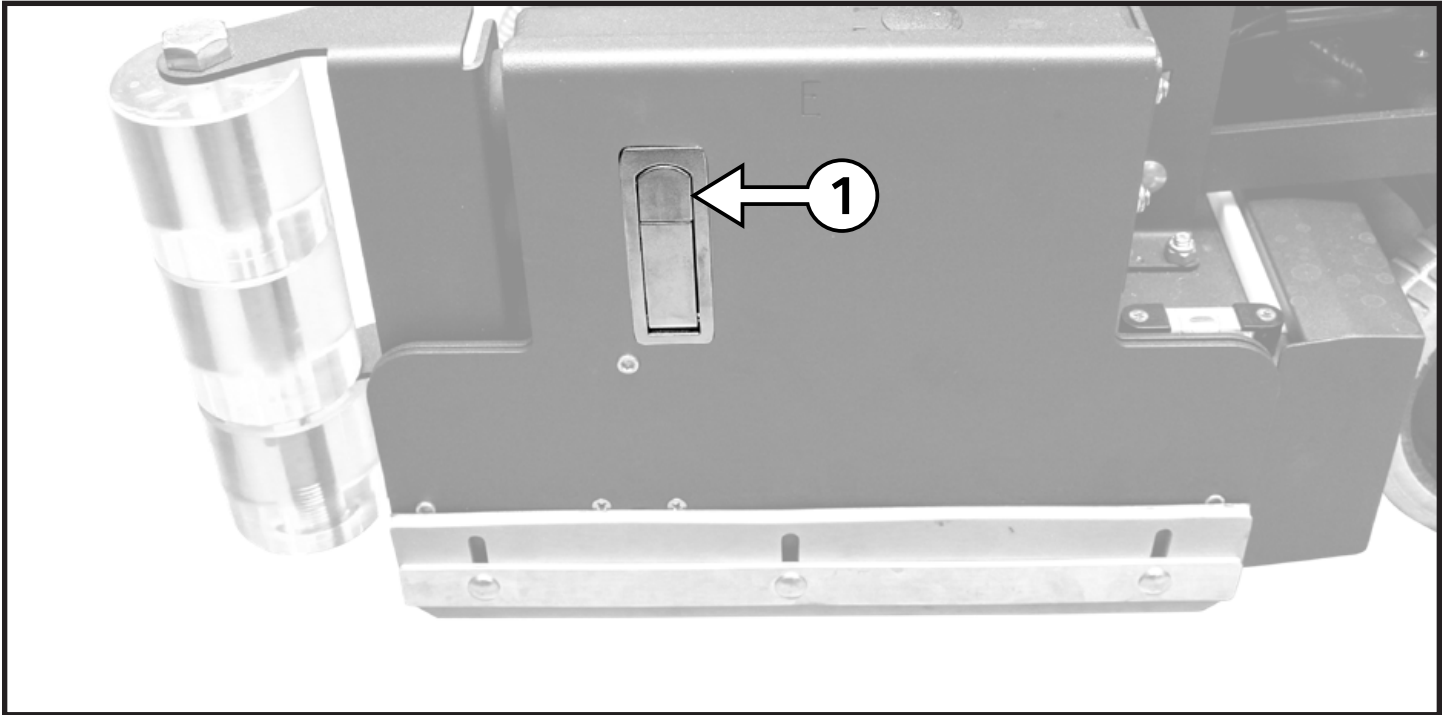

REMOVE ORBITAL PADS

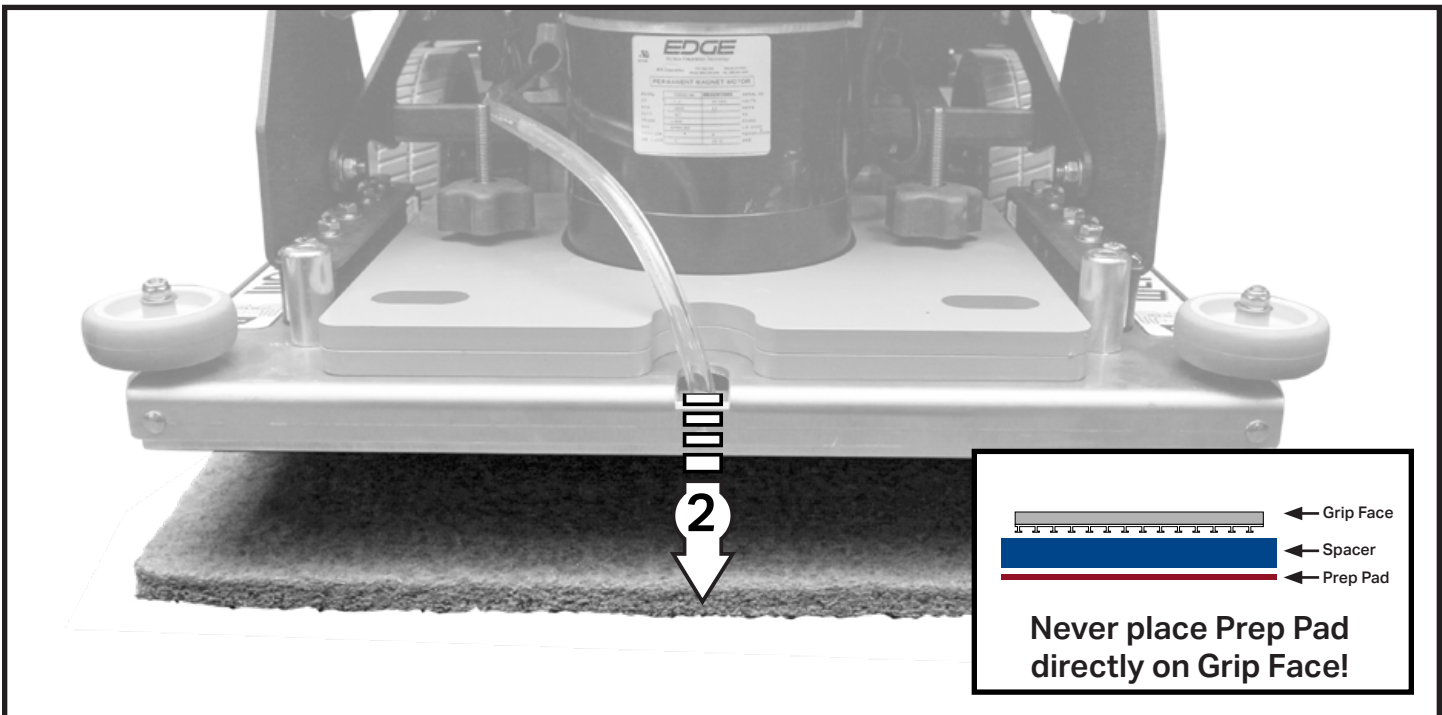
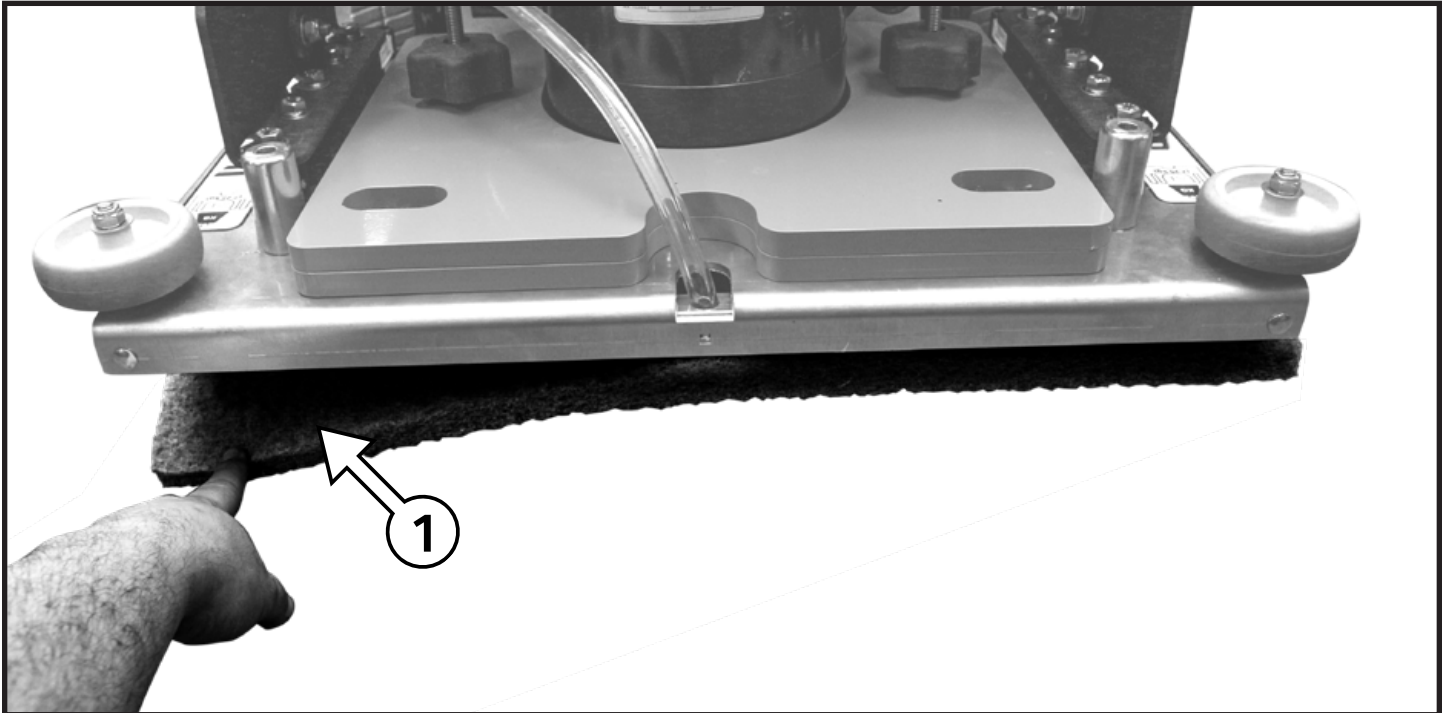
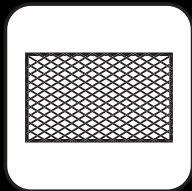

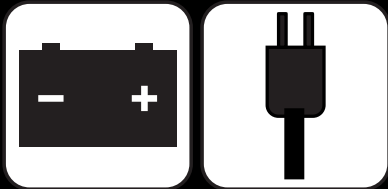

CHARGE BATTERIES



Please refer to OEM Charger Operating Instructions for more information.

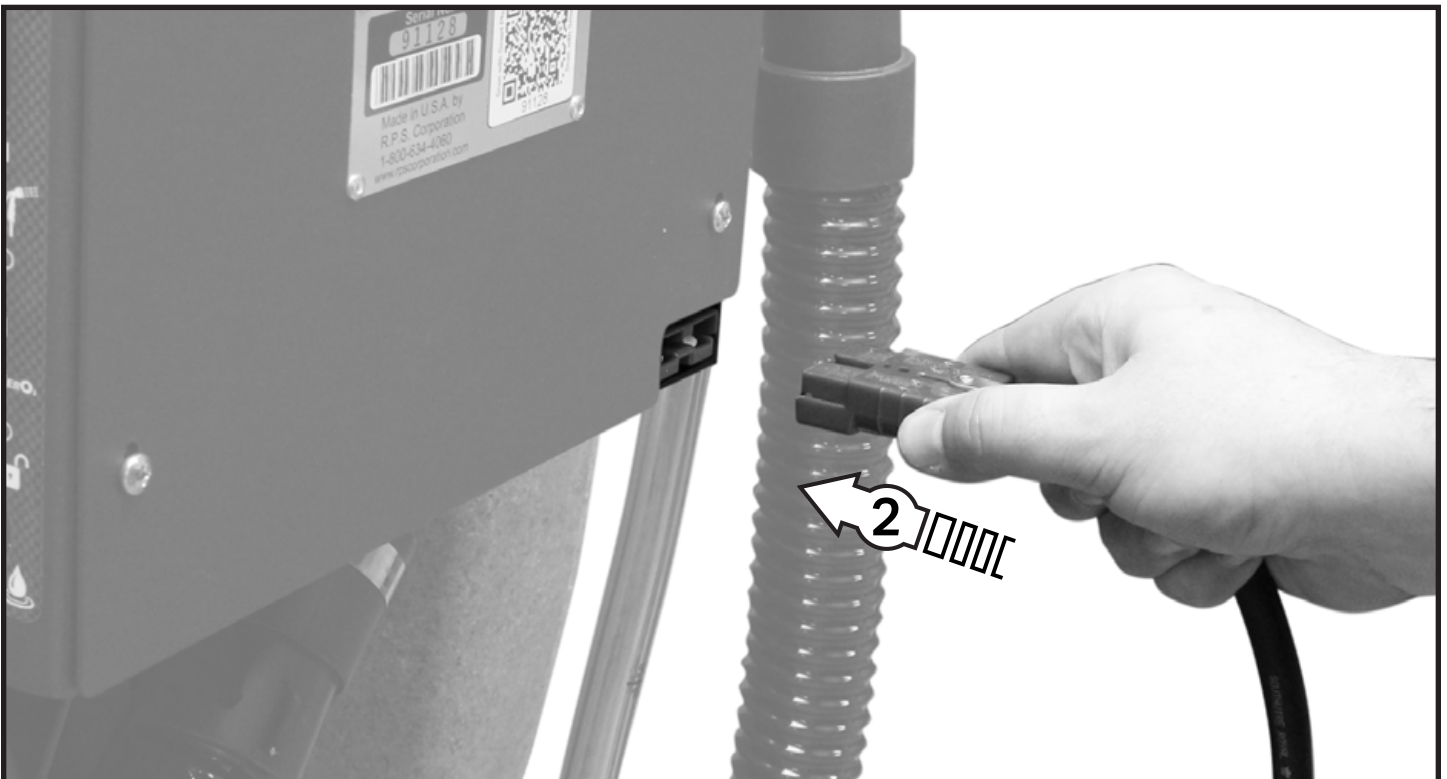

BATTERY CHARGERS



Console / WET / Domestic Chargers:



AC Power IN: 120VAC / 60Hz
DC Power OUT:
Micro-HD: 24VDC / 12A
Mini-HD: 24VDC / 25A
Mag-HD: 24VDC / 30A



Please refer to OEM Charger Operating Instructions for more information.

Onboard / AGM / International Chargers:



AC Power: 80-270VAC / 50-60Hz
DC Power OUT: 24VDC / 27A

Please refer to OEM Charger Operating Instructions for more information.



MILITARY GRADE CENTRAL COMMAND - STATUS LIGHT CODES

Status Light Guide

Below is a list of self-help actions. Try to use this list before you contact your service agent. Go to the number in the list which matches the number of indicator light flashes and follow the instructions.

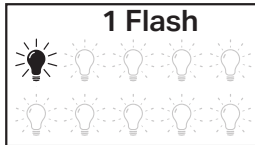

The battery needs charging, there is a bad connection to the battery or dependent on programming, may indicate that the battery lockout function is active and the controller is in a restricted mode of operation. Check the connections to the battery. If the connections are good, try charging the battery.

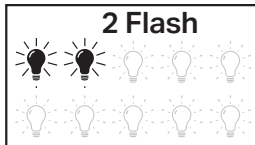

There is a bad connection to the motor. Check all connections between the motor and the controller.

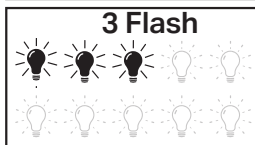

The motor has a short circuit to a battery connection. Contact your service agent.

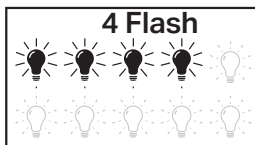

The battery charge level has fallen below the Battery Lockout Level and the controller is inhibiting certain machine functions. Charge the battery.

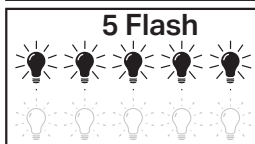

Not Used.

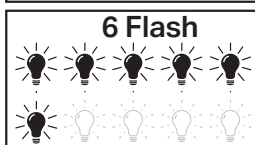

The controller is being inhibited from driving, this may be because the battery charger is connected.

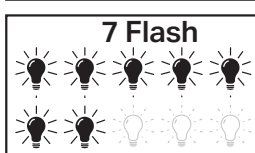

A throttle fault is indicated. Make sure that the throttle is in the rest position before switching on the machine.

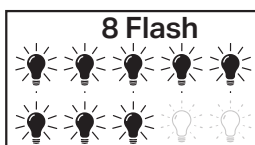

A controller fault is indicated. Make sure that all connections are secure.

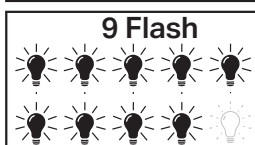

The parking brakes have a bad connection. Check the parking brake and motor connections. Make sure the controller connections are secure.

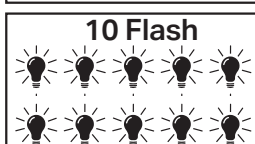

An excessive voltage has been applied to the controller. This is usually caused by a poor battery connection. Check the battery connections.

PM SHEET

CUSTOMER & MACHINE INFORMATION			
Customer:			Email:
Address:			Phone:
City:	State:	Zip:	Contact:
Serial #:	Model #:	Work Order #:	

NOTE: Start with Machine filled at least with ½ Tank of water. Turn ON Machine and Test Functionality of Machine

CHECK OPERATION & CONDITION OF	IN SPEC	REPAIR	PROBLEM
Key Switch			
Battery Gauge			
Deck Up / Down – Brush Switch			
Brush Pressure +/- Toggle (Optional)			
Vacuum Switch - ON / OFF			
Squeegee Lever - Up/Down			
Solution Switch - ON/OFF			
Solution Flow Lever +/-			
Green Drive Buttons - L & R			
Reverse Toggle Switch			
E-Stop (Optional)			

NOTE: Drain Solution & Recovery Tank fully. Rinse out Recovery Tank

CLEAN & INSPECT – SOLUTION TANK	IN SPEC	REPAIR	PROBLEM
Solution Fill Screen - Mesh			
Solution Fill Hose (Optional)			
Solution Inline Filter			
Vacuum Muffler Drain Hose			
Battery Drain Hose			

BRUSH CONDITION – SCRUB DECK			
Deck Curtains/Wipers	Good	Worn	Needs Replacement
Brush Sockets: (2-Disk)/(4-Cylindrical)	Good	Worn	Needs Replacement
Brush Drivers: (2-Disk)/(4-Cylindrical)	Good	Worn	Needs Replacement
Scrub Brush Fiber Length	Brush 1 Length:	Brush 2 Length:	Rotated Brushes: Y / N

CLEAN & INSPECT – SCRUB DECK	IN SPEC	REPAIR	PROBLEM
Scrub Deck Linkage Pivot Points			
Scrub Deck Lift Actuator			
Scrub Deck Level (Orbital Only)			
Scrub Motor Wires			

CLEAN & INSPECT - SQUEEGEE	IN SPEC	REPAIR	PROBLEM
Remove and Wipe off Squeegee			
Check and Rotate Blades as Needed			
Caster Wheels and Height			
Pitch Adjust			
Check Pivot and Knobs			
Squeegee Vac Hose			

CLEAN & INSPECT – RECOVERY TANK	IN SPEC	REPAIR	PROBLEM
Recovery Tank Lid & Gasket			
Vacuum Float Ball Screen			
Vacuum Box White Filter			
solution Site Tube			

CLEAN & INSPECT – DRIVE	IN SPEC	REPAIR	PROBLEM
Drive Wheels & Casters Condition			
Grease Caster Swivel			

BATTERY #1	HYDROMETER READING	WATER CLARITY (Circle One)		WATER LEVEL (Circle One)	
Cell A		Clear	Dark	Overfilled	OK Low
Cell B		Clear	Dark	Overfilled	OK Low
Cell C		Clear	Dark	Overfilled	OK Low
Cell D/2A		Clear	Dark	Overfilled	OK Low
Cell E/2B		Clear	Dark	Overfilled	OK Low
Cell F/2C		Clear	Dark	Overfilled	OK Low
BATTERY #2	HYDROMETER READING	WATER CLARITY (Circle One)		WATER LEVEL (Circle One)	
Cell A		Clear	Dark	Overfilled	OK Low
Cell B		Clear	Dark	Overfilled	OK Low
Cell C		Clear	Dark	Overfilled	OK Low
Cell D/4A		Clear	Dark	Overfilled	OK Low
Cell E/4B		Clear	Dark	Overfilled	OK Low
Cell F/4C		Clear	Dark	Overfilled	OK Low
CLEAN & INSPECT - BATTERIES		IN SPEC	REPAIR	PROBLEM	
Battery Terminals					
Battery Cables					
Torque Battery Nuts 11ft/lbs					

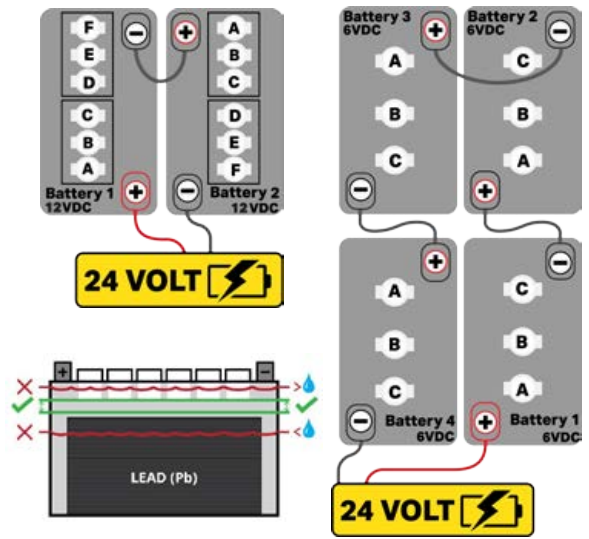

OPERATE & CONFIRM	IN SPEC	REPAIR	PROBLEM
Fill Solution Tank – ¾ Full			
Scrub & Dry			
Fine Tune Squeegee Adjustments			

COMMENTS & RECOMMENDATIONS

Servicing Distributor:

Technician's Name:	Date:	Signature:
Customer's Name:	Date:	Signature:

MEMBRANE/TOUCH SCREEN ERROR CODES

Membrane Panel Code	Touch screen Code	Error	Type	Description	Action	Remedy
10	100A	Bad Personality	hard/soft	Incompatible options programmed or a checksum failure	The machine is disabled or continues operating with factory default parameters	Check programming options and/or reprogram EEPROM
11	110A	Initial throttle fault	soft	Throttle is engaged at power up preventing a successful return to idle state	Machine remains in a pre-idle condition until the active throttle condition goes away	Take your foot off the gas
12	120A		hard			
13	130A	Memory fault	hard/soft	An error was detected during an EEPROM read access	The machine is disabled or continues operating with factory default parameters	Cycle keyswitch. If problem persists change control board
14	140A	Dead battery	hard	The battery voltage has dropped below NN.n Volts	The machine is disabled	Charge or replace batteries
15	150A	Low battery charge	soft	The battery voltage has dropped below NN.n Volts and all but the transport motor have been disabled	All but the transport motor are disabled	Charge battery
16	160A	Overheat CPU	hard	The microcontroller hardware has had an over temperature failure	The controller is switched off	Keyswitch off, wait ten minutes, keyswitch on. If problem persists change control board
17	170A					
18	180A	Transport idle current fault	hard	An abnormally high idle current has been detected in the transport motor (operational motor)	The machine is disabled	
19	190A	Brush idle current fault	soft	An abnormally high idle current has been detected in the brush motor (operational motor)	Brush, deck actuator and water/suds are disabled	
20	200A	Vacuum idle current fault	soft	An abnormally high idle current has been detected in the vacuum motor (operational motor)	Vacuum motor is disabled	
21	210A	Squeegee idle current fault	soft	An abnormally high idle current has been detected in the squeegee motor (operational motor)	Squeegee motor is disabled	
22	220A		soft			
23	230A	Transport motor relay not open	hard	The main traction relay was detected closed during power on	The machine is disabled	Keyswitch off, wait ten seconds, keyswitch on. If problem persists change control board
24	240A	Transport motor relay not closed	hard	The main traction relay was detected open after being energized during power on	The machine is disabled	
25	250A	Throttle fault	hard	An illegal voltage has been read from the throttle feedback circuit	The machine is disabled	Check throttle action and voltages
26	260A	Brake fault	hard	An illegal voltage has been read from the brake feedback circuit	The machine is disabled	
27	270A	Alarm fault	soft			
28	280A	Auxilliary output 1 fault	soft			
29	290A	Auxilliary output 2 fault	soft			
68	680A	Auxilliary output 3 fault	soft			
30	300A	Deck actuator idle current over limit	soft	An abnormally high idle current has been detected in the deck actuator motor	Brush, deck actuator and water/suds are disabled	

MEMBRANE/TOUCH SCREEN ERROR CODES

Membrane Panel Code	Touch screen Code	Error	Type	Description	Action	Remedy
31	310A	Transport motor stalled	hard	An energized transport motor is not rotating		
32	320A	Transport motor circuit current over limit	hard	There is excessive current in the transport motor drive circuit		
33	330A	Transport motor circuit current over limit	hard	There is excessive current in the transport motor drive circuit	The machine is disabled	
34	340A	Brush motor current over software limit	soft	The brush motor current has exceed the software limit	Brush, deck actuator and water/suds are disabled	
35	350A	Brush motor current over hardware limit	soft	The brush motor current has exceed the absolute hardware limit	Brush, deck actuator and water/suds are disabled	
36	360A	Open circuit detected in brush motor	soft	An electrically open condition has been detected in the brush motor circuit	Brush, deck actuator and water/suds are disabled	
37	370A					
38	380A					
39	390A					
40	400A	Transport motor current over hardware limit	hard	The transport motor current has exceed the absolute hardware limit	The machine is disabled	
41	410A	Transport motor current over hardware limit	hard	The transport motor current has exceed the absolute hardware limit	The machine is disabled	
42	420A					
43	430A	12VDC power supply outside acceptable limits	hard	The 12VDC supply voltage is less than 11.75V or greater than 12.25 volts	The machine is disabled	check batteries
44	440A					
45	450A	Deck actuator motor current over software limit	soft	The deck actuator current has exceed the software limit	Brush, deck actuator and water/suds are disabled	
46	460A	Vacuum motor current over hardware limit	soft	The vacuum motor current has exceed the software limit	The vacuum motor is disabled	
47	470A	Deck actuator motor current over hardware limit	soft	The deck actuator current has exceed the absolute hardware limit	Brush, deck actuator and water/suds are disabled	
48	480A	Squeegee motor current over software limit	soft	The squeegee motor current has exceed the software limit	The squeegee actuator is disabled	
49	490A	Vacuum motor current over software limit	soft	The vacuum motor current has exceed the software limit	The vacuum motor is disabled	
50	500A	Squeegee motor current over hardware limit	soft	The squeegee motor current has exceed the absolute hardware limit	The squeegee actuator is disabled	
51	510A					
52	520A	Open circuit detected in vacuum motor	soft	An electrically open condition has been detected in the vacuum motor circuit	The vacuum motor is disabled	
53	530A					
54	540A					
55	550A	Open circuit detected in deck actuator	soft	An electrically open condition has been detected in the deck actuator circuit	Brush, deck actuator and water/suds are disabled	
56	560A					
23	570A	Transport motor relay not open	hard	The main traction relay was detected closed during power on	The machine is disabled	Keyswitch off, wait ten seconds, keyswitch on. If problem persists change control board
23	580A	Transport motor relay not open	hard	The main traction relay was detected closed during power on	The machine is disabled	Keyswitch off, wait ten seconds, keyswitch on. If problem persists change control board
59	590A	Squeegee motor stalled	soft	An energized squeegee actuator is not moving	The squeegee actuator is disabled	
60	600A	Deck actuator stalled	soft	An energized deck actuator is not rotating	Brush, deck actuator and water/suds are disabled	
61	610A					
62	620A	Brush motor stalled	soft	An energized brush motor is not rotating	Brush, deck actuator and water/suds are disabled	
63	630A	vacuum motor stalled	soft	An energized vacuum motor is not rotating	The vacuum motor is disabled	
64	640A					
65	650A					
66	660A	Overheat MOSFET	hard	The transport motor drive circuit has had an over temperature failure	The machine is disabled	
67	670A	Battery over voltage	hard	The battery voltage is above acceptable limits	The machine is disabled	check batteries / wiring

TOUCH SCREEN SCHEMATICS

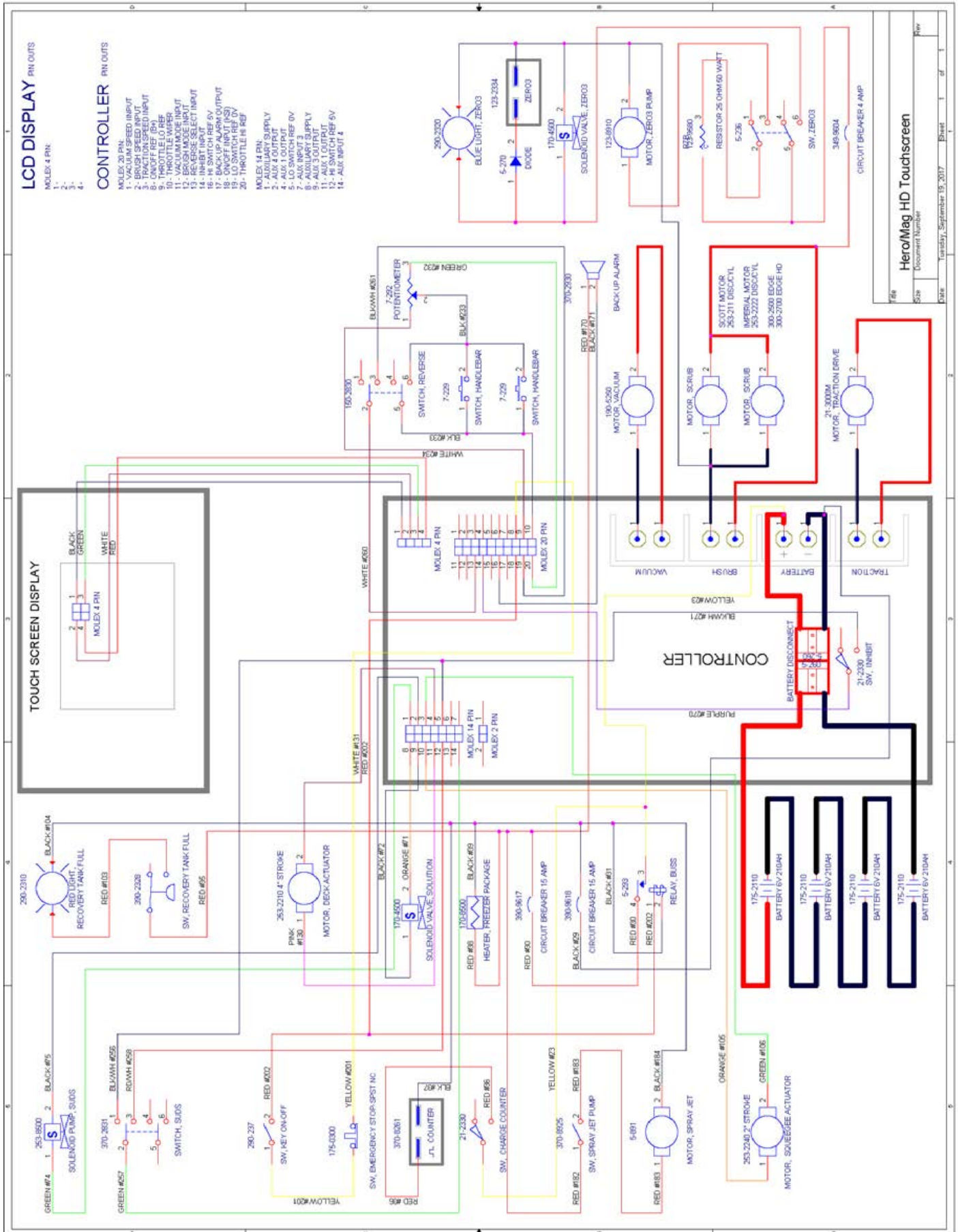

File	Document Number	Rev
Hero/Mag HD Touchscreen		
Size		
Date	Tuesday, September 19, 2017	
Sheet	1	of 1

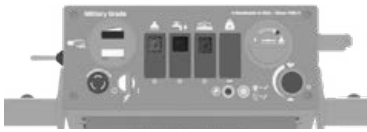

MILITARY GRADE SCHEMATIC

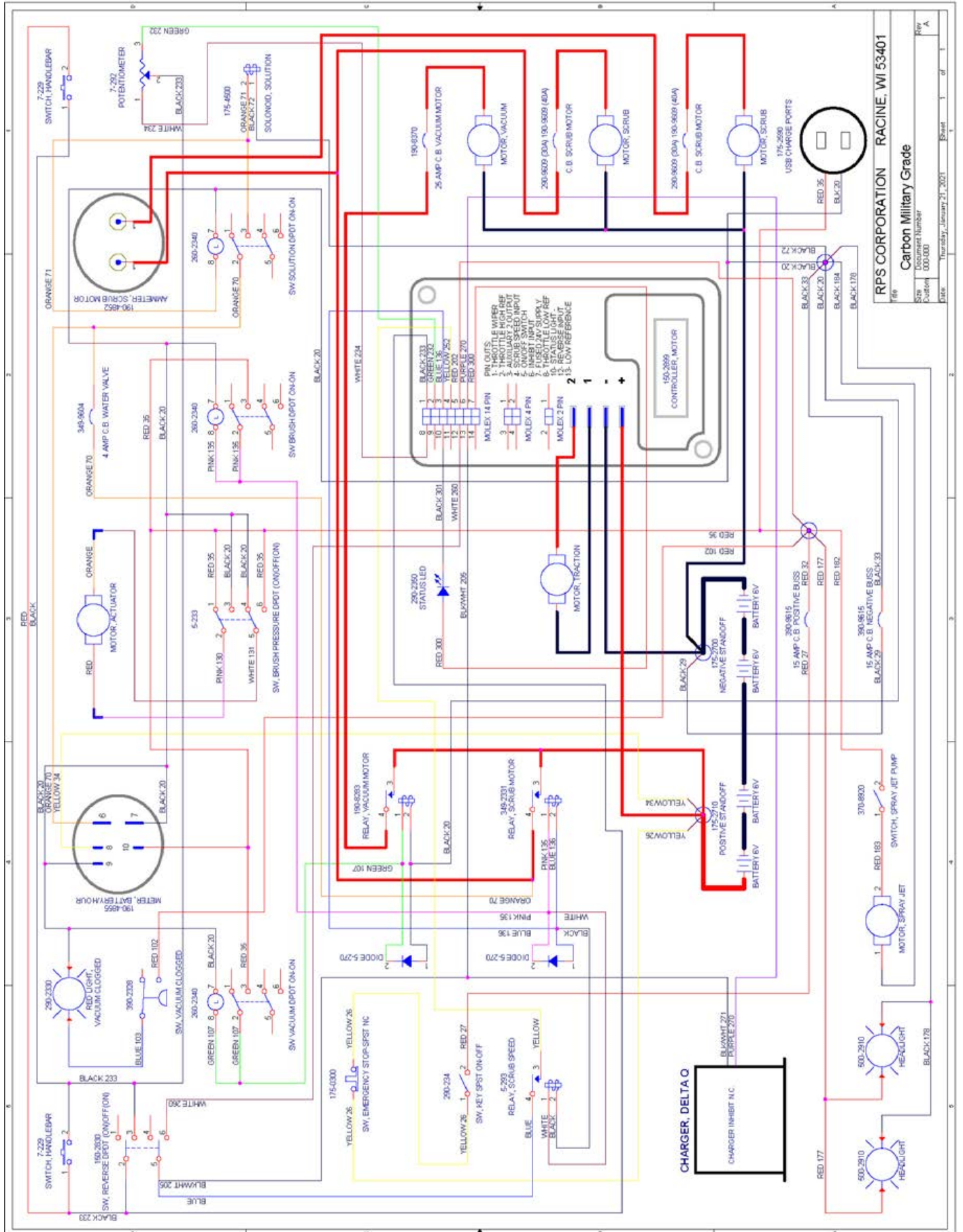

MEMBRANE SCHEMATICS



Rev	1	of	1
Size	A		
Document Number	Walk Behind Membrane Panel		
Date	Thursday, January 26, 2024	Sheet	1

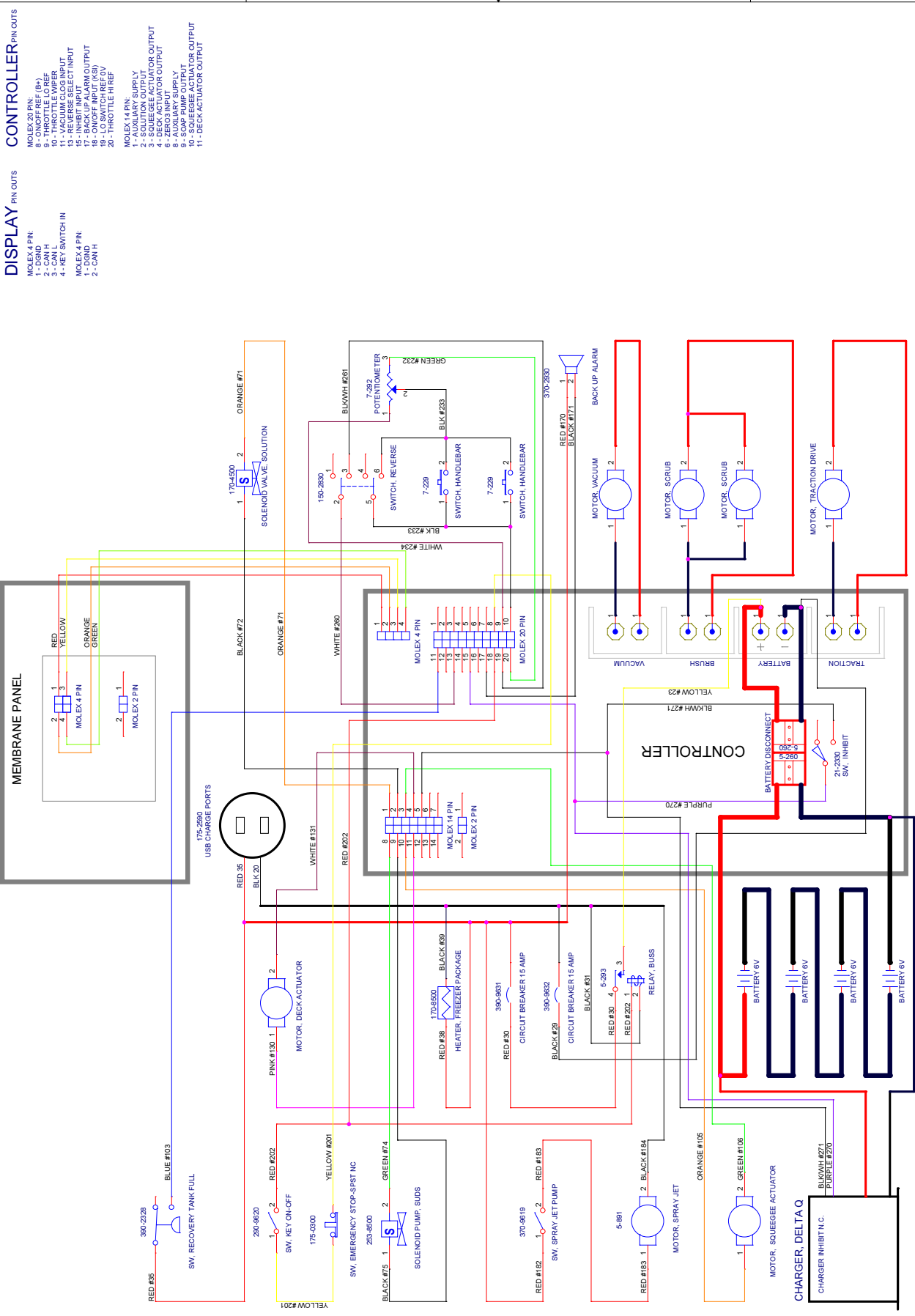

- DISPLAY PIN OUTS**
- MOLEX 4 PIN:
 - 1 - CAN L
 - 2 - CAN H
 - 3 - VET SWITCH IN
 - MOLEX 4 PIN:
 - 1 - CAN H
 - 2 - CAN L
- CONTROLLER PIN OUTS**
- MOLEX 14 PIN:
 - 1 - GNDGEE REF (+)
 - 2 - THROTTLE LO REF
 - 3 - THROTTLE WIPER
 - 4 - REVERSE SELECT INPUT
 - 5 - INHIBIT INPUT
 - 6 - SOLUTION OUTPUT
 - 7 - ON/OFF INPUT (K50)
 - 8 - LO SWITCH REF (V)
 - 9 - THROTTLE IN REF
 - MOLEX 14 PIN:
 - 1 - AUXILIARY SUPPLY
 - 2 - SOLUTION OUTPUT
 - 3 - SQUEEGEE ACTUATOR OUTPUT
 - 4 - DECK ACTUATOR OUTPUT
 - 5 - VET SWITCH IN
 - 6 - AUXILIARY SUPPLY
 - 7 - SOAP PUMP OUTPUT
 - 8 - SOAP PUMP OUTPUT
 - 9 - DECK ACTUATOR OUTPUT
 - 10 - DECK ACTUATOR OUTPUT



MEMBRANE PANEL (ZERO3 ®)

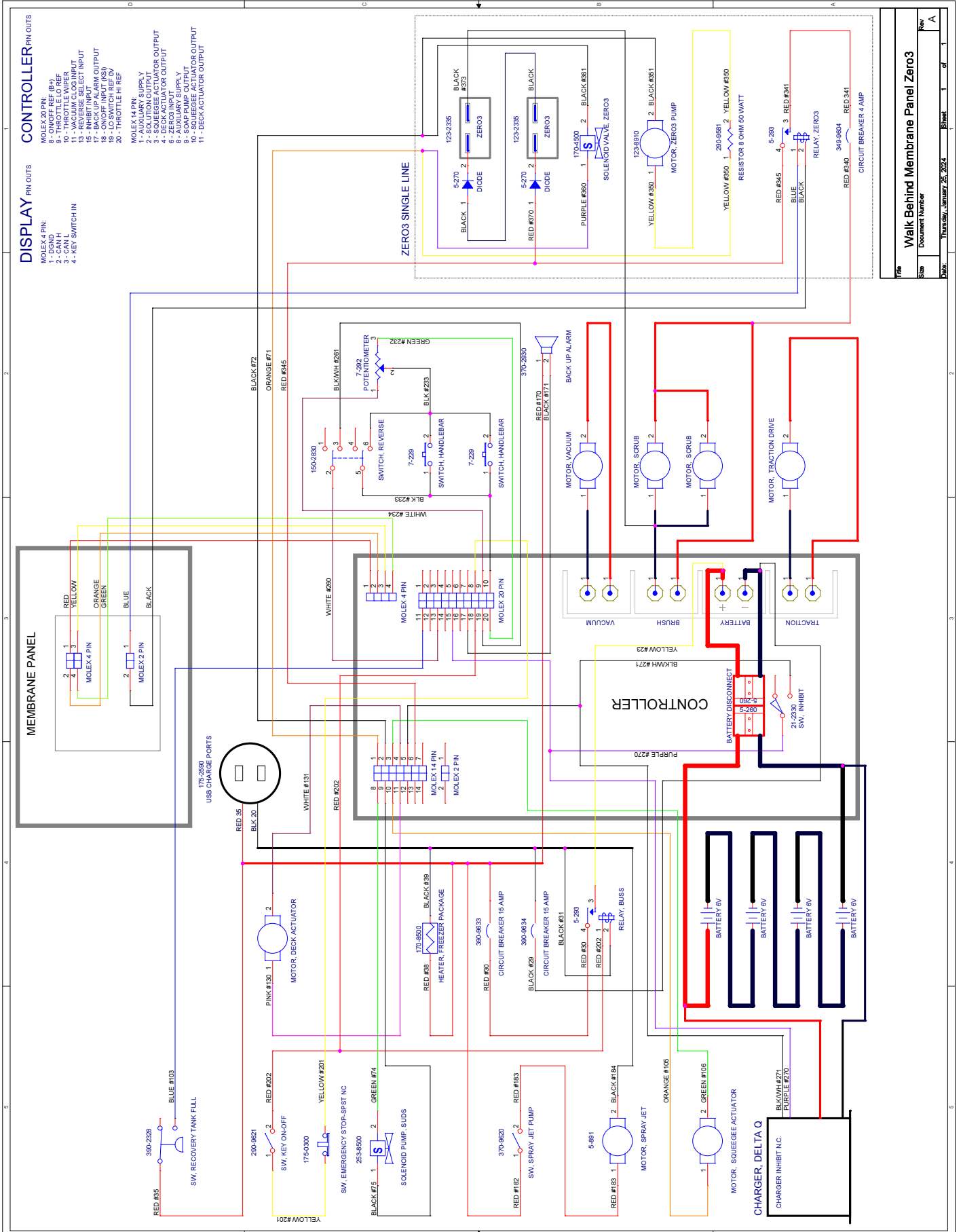

File	Walk Behind Membrane Panel Zero3		
Size	Document Number		
Date	Thursday, January 26, 2024	Sheet	1 of 1
Rev	A		

LEGACY SCHEMATIC

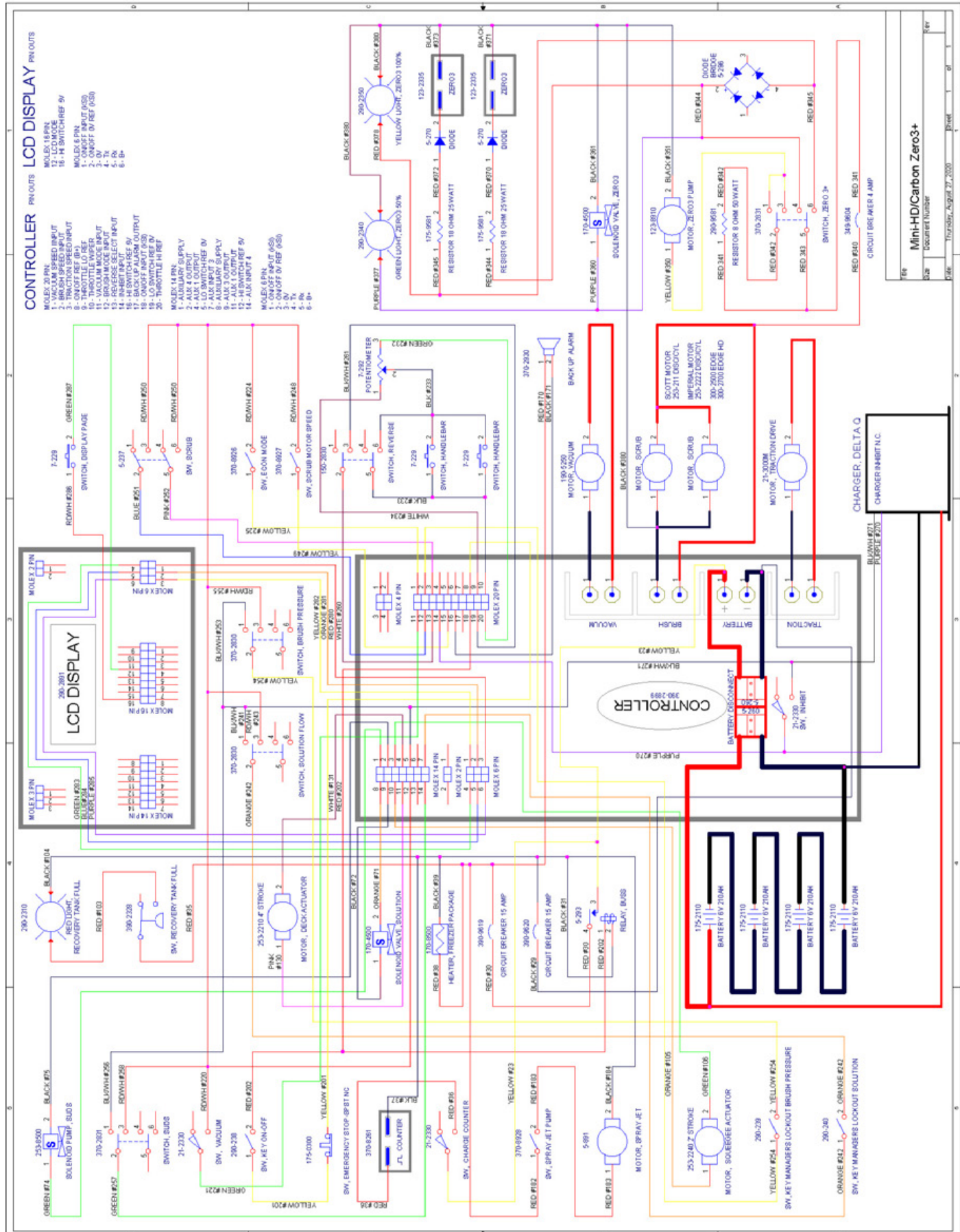

Central Command Decals

Military Grade



Part #:175-2021

Legacy

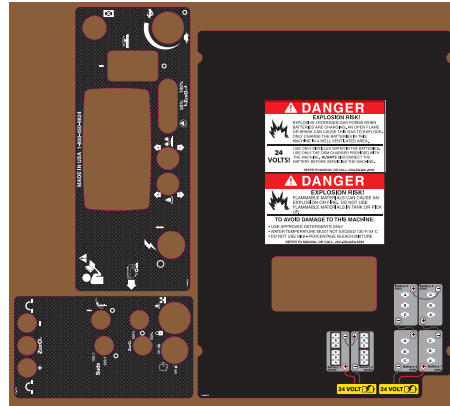

Part #:175-2020

Membrane/Touch Screen



Part #:175-2023

Models / Options / Squeegee Size Decals



Part #:164-1515



Part #:370-7215



Part #:175-1523



Part #:175-1521



Part #:175-1515



Part #:370-7214



Part #:123-1837



Part #:264-1515



Part #:370-7219



Part #:123-1838



Part #:33-1602



Part #:37-1602



Part #:41-1602



Part #:45-1602



Part #:123-1843

ROUND DISK BRUSHES:

NOTICE

The ## in Disk Column Denotes Desk Pad Size: 13" or 20"

BRUSHES	DISK	LEVEL
Super Grit	##-382SS	Very High
Tough Grit	##-382S	High
Midi Grit	##-382C	Medium
Light Grit	##-382PS	Moderate
Poly	##-382P	Light
Nylon	##-382N	Light
Tampico	##-382T	Light
Pad Driver	##-382D	
Diamond Driver	##-382DD	

ROUND DISK PADS:

NOTICE

The ## in Disk Column Denotes Desk Pad Size: 13" or 20"

DISK PADS	DISK	LEVEL	COLOR
Super Black	##-422BB	Very High	Black
Black	##-422B	High	Black
Brown	##-422BR	High	Brown
Green	##-422G	Medium	Green
Blue	##-422BL	Moderate	Blue
Red	##-422R	Moderate	Red
White	##-422W	Light	White

CYLINDRICAL BRUSHES:

BRUSHES	MODEL 25" CYLINDRICAL	LEVEL
Tough Grit	236-697S	High
Midi Grit	236-697C	Medium
Light Grit	236-697PS	Moderate
Nylon	236-697N	Light
Tampico	236-697T	Light

EDGE PADS AND SCREENS:

DESCRIPTION	24"×14" SCRUBDECK	20"×14" SCRUBDECK	28"×14" SCRUBDECK
White Pad	N / A	EDGE-4005	EDGE-4054
Red Pad	EDGE-2404	EDGE-4004	EDGE-4053
Blue Pad	EDGE-2403	EDGE-4003	EDGE-4052
Green Pad	EDGE-2402	EDGE-4002	EDGE-4051
Black Pad	EDGE-2401	EDGE-4001	EDGE-4050
White Driver Pad	N / A	EDGE-4025	EDGE-4058
Tile/Grout Renovator Pad	N / A	EDGE-4018	EDGE-4059
Microfiber Pad	N / A	EDGE-4036	EDGE-4060
Dominator HD Strip Pad	N / A	EDGE-4006	EDGE-4061
Maroon ECO Prep Pad	EDGE-2407	EDGE-4007	EDGE-4062
Remover Burnishing Pad	N / A	EDGE-4008	EDGE-4063
Porko Burnishing Pad	N / A	EDGE-4017	
Velcro Pad	N / A	300-4023	

EDGE GRIP FACE:

DESCRIPTION	PART#
20", 24" & 28" Mighty Lok Grip Face	300-01037Z

V2.1 SQUEEGEE BLADE KITS & COMPLETE SQUEEGEE ASSEMBLIES:

SQUEEGEE SIZE	20" DISK DECKS	26" DISK DECKS	25" CYL. DECKS	20" EDGE DECKS	24" EDGE DECKS	28" EDGE DECKS
33" Squeegee	Standard	Standard	Standard	Standard	Standard	Standard
37" Squeegee	Optional	Optional	Optional	Optional	Optional	Optional

SQUEEGEE SIZE	LINATEX BLADE KIT	COMPLETE SQUEEGEE ASSEMBLIES
33" Squeegee	433-721L	233-2181
37" Squeegee	437-721L	237-2181

SQUEEGEE MATERIAL:	USED FOR:
LINATEX	Provides best wear and tear resistance. Not designed for use with harsh chemicals.

NOTICE

Squeegee blade kits include (1) Rear Blade, (1) Front Blade, and (2) Caster Wheels with hardware.

NOTICE

Squeegee Assemblies (complete) listed above all come with Linatex blades.

NOTICE

Size is shown as a decal at the top of the steel squeegee body on all squeegee's.



ROUND DISK BRUSHES:

NOTICE

The ## in Disk Column Denotes Desk Pad Size: 13" or 14"

BRUSHES	DISK	LEVEL
Super Grit	##-382SS	Very High
Tough Grit	##-382S	High
Midi Grit	##-382C	Medium
Light Grit	##-382PS	Moderate
Poly	##-382P	Light
Nylon	##-382N	Light
Tampico	##-382T	Light
Pad Driver	##-382D	
Diamond Driver	##-382DD	

ROUND DISK PADS:

NOTICE

The ## in Disk Column Denotes Desk Pad Size: 13" or 14"

DISK PADS	DISK	LEVEL	COLOR
Super Black	##-422BB	Very High	Black
Black	##-422B	High	Black
Brown	##-422BR	High	Brown
Green	##-422G	Medium	Green
Blue	##-422BL	Moderate	Blue
Red	##-422R	Moderate	Red
White	##-422W	Light	White

CYLINDRICAL BRUSHES:

BRUSHES	MODEL 25" CYLINDRICAL	MODEL 29" CYLINDRICAL	LEVEL
Tough Grit	236-697S	276-697S	High
Midi Grit	236-697C	276-697C	Medium
Light Grit	236-697PS	276-697PS	Moderate
Nylon	236-697N	276-697N	Light
Tampico	236-697T	276-697T	Light

EDGE PADS AND SCREENS:

DESCRIPTION	24"×14" SCRUBDECK	28"×14" SCRUBDECK
White Pad	N/A	EDGE-4054
Red Pad	EDGE-2404	EDGE-4053
Blue Pad	EDGE-2403	EDGE-4052
Green Pad	EDGE-2402	EDGE-4051
Black Pad	EDGE-2401	EDGE-4050
White Driver Pad	N/A	EDGE-4058
60 Grit Sand Screen	N/A	EDGE-4059
80 Grit Sand Screen	N/A	EDGE-4060
100 Grit Sand Screen	N/A	EDGE-4061
120 Grit Sand Screen	N/A	EDGE-4062
150 Grit Sand Screen	N/A	EDGE-4063
80 Grit Sand Paper	N/A	N/A
100 Grit Sand Paper	N/A	N/A
400 Grit Diamond Polishing Pad	N/A	EDGE-4013
800 Grit Diamond Polishing Pad	N/A	EDGE-4014

1500 Grit Diamond Polishing Pad	N/A	EDGE-4015
3000 Grit Diamond Polishing Pad	N/A	EDGE-4016
6000 Grit Diamond Polishing Pad	N/A	EDGE-4070
Tile/Grout Renovator Pad	N/A	EDGE-4048
Dominator HD Strip Pad	N/A	EDGE-4055
Maroon ECO Prep Pad	EDGE-2407	EDGE-4056

EDGE GRIP FACE:

DESCRIPTION	PART#
24"-28" Mighty Lok Grip Face	300-01037Z

V2.1 SQUEEGEE BLADE KITS & COMPLETE SQUEEGEE ASSEMBLIES:

SQUEEGEE SIZE	26" DISK DECKS	28" DISK DECKS	25" CYL. DECKS	29" CYL. DECKS	24" EDGE DECKS	28" EDGE DECKS
37" Squeegee	Standard	Standard	Standard	Standard	Standard	Standard
41" Squeegee	Optional	Optional	Optional	Optional	Optional	Optional

SQUEEGEE SIZE	LINATEX BLADE KIT	COMPLETE SQUEEGEE ASSEMBLIES
37" Squeegee	437-721L	37-2181
41" Squeegee	441-721L	41-2181

SQUEEGEE MATERIAL:	USED FOR:
LINATEX	Provides best wear and tear resistance. Not designed for use with harsh chemicals.

NOTICE

Squeegee blade kits include (1) Rear Blade, (1) Front Blade, and (2) Caster Wheels with hardware.

NOTICE

Squeegee Assemblies (complete) listed above all come with Linatex blades.

NOTICE

Size is shown as a decal at the top of the steel squeegee body on all squeegee's.



ROUND DISK BRUSHES:

NOTICE

The ## in Disk Column Denotes Desk Pad Size: 15", 16" or 17"

BRUSHES	DISK	LEVEL
Super Grit	##-382SS	Very High
Tough Grit	##-382S	High
Midi Grit	##-382C	Medium
Light Grit	##-382PS	Moderate
Poly	##-382P	Light
Nylon	##-382N	Light
Tampico	##-382T	Light
Pad Driver	##-382D	
Diamond Driver	##-382DD	

ROUND DISK PADS:

NOTICE

The ## in Disk Column Denotes Desk Pad Size: 15", 16" or 17"

DISK PADS	DISK	LEVEL	COLOR
Super Black	##-422BB	Very High	Black
Black	##-422B	High	Black
Brown	##-422BR	High	Brown
Green	##-422G	Medium	Green
Blue	##-422BL	Moderate	Blue
Red	##-422R	Moderate	Red
White	##-422W	Light	White

CYLINDRICAL BRUSHES:

BRUSHES	MODEL 29" CYLINDRICAL	MODEL 33" CYLINDRICAL	LEVEL
Tough Grit	276-697S	316-697S	High
Midi Grit	276-697C	316-697C	Medium
Light Grit	276-697PS	316-697PS	Moderate
Nylon	276-697N	316-697N	Light
Tampico	276-697T	316-697T	Light

EDGE PADS AND SCREENS:

DESCRIPTION	28"×14" SCRUBDECK	32"×14" SCRUBDECK
White Pad	EDGE-4054	EDGE-5005
Red Pad	EDGE-4053	EDGE-5004
Blue Pad	EDGE-4052	EDGE-5009
Green Pad	EDGE-4051	EDGE-5002
Black Pad	EDGE-4050	EDGE-5001
White Driver Pad	EDGE-4058	N / A
60 Grit Sand Screen	EDGE-4059	N / A
80 Grit Sand Screen	EDGE-4060	N / A
100 Grit Sand Screen	EDGE-4061	EDGE-5028
120 Grit Sand Screen	EDGE-4062	EDGE-5029
150 Grit Sand Screen	EDGE-4063	N / A
Tile/Grout Renovator Pad	EDGE-4048	N / A
Dominator HD Strip Pad	EDGE-4055	N / A
Maroon ECO Prep Pad	EDGE-4056	EDGE-5007
Remover Burnishing Pad	EDGE-4057	EDGE-5008
Porko Burnishing Pad	EDGE-4047	N / A
Velcro Pad	300-4024	N / A

EDGE GRIP FACE:

DESCRIPTION	PART#
28"-32" Mighty Lok Grip Face	300-01037Z

V2.1 SQUEEGEE BLADE KITS & COMPLETE SQUEEGEE ASSEMBLIES:

SQUEEGEE SIZE	30" DISK DECKS	34" DISK DECKS	29" CYL. DECKS	33" CYL. DECKS	28" EDGE DECKS	32" EDGE DECKS
41" Squeegee	Standard	Optional	Standard	Optional	Standard	Optional
45" Squeegee	Optional	Standard	Optional	Standard	Optional	Standard

SQUEEGEE SIZE	LINATEX BLADE KIT	COMPLETE SQUEEGEE ASSEMBLIES
41" Squeegee	441-721L	41-2181
45" Squeegee	445-721L	45-2181

SQUEEGEE MATERIAL:	USED FOR:
LINATEX	Provides best wear and tear resistance. Not designed for use with harsh chemicals.

NOTICE

Squeegee blade kits include (1) Rear Blade, (1) Front Blade, and (2) Caster Wheels with hardware.

NOTICE

Squeegee Assemblies (complete) listed above all come with Linatex blades.

NOTICE

Size is shown as a decal at the top of the steel squeegee body on all squeegee's.





1711 South Street
Racine, WI 53404
www.tomcatequip.com
1-262-681-3583