

Operating Instructions (EN)

Models:

Pilot

26"-28" Disk
25" - 29" Cylindrical
24" & 28" ORBITAL

GTX

26", 30" Disk
25", 29", 33" Cylindrical
28", 32' ORBITAL

GTR

30", 34" & 36" Disk
29", 33", 37" Cylindrical
N/A ORBITAL

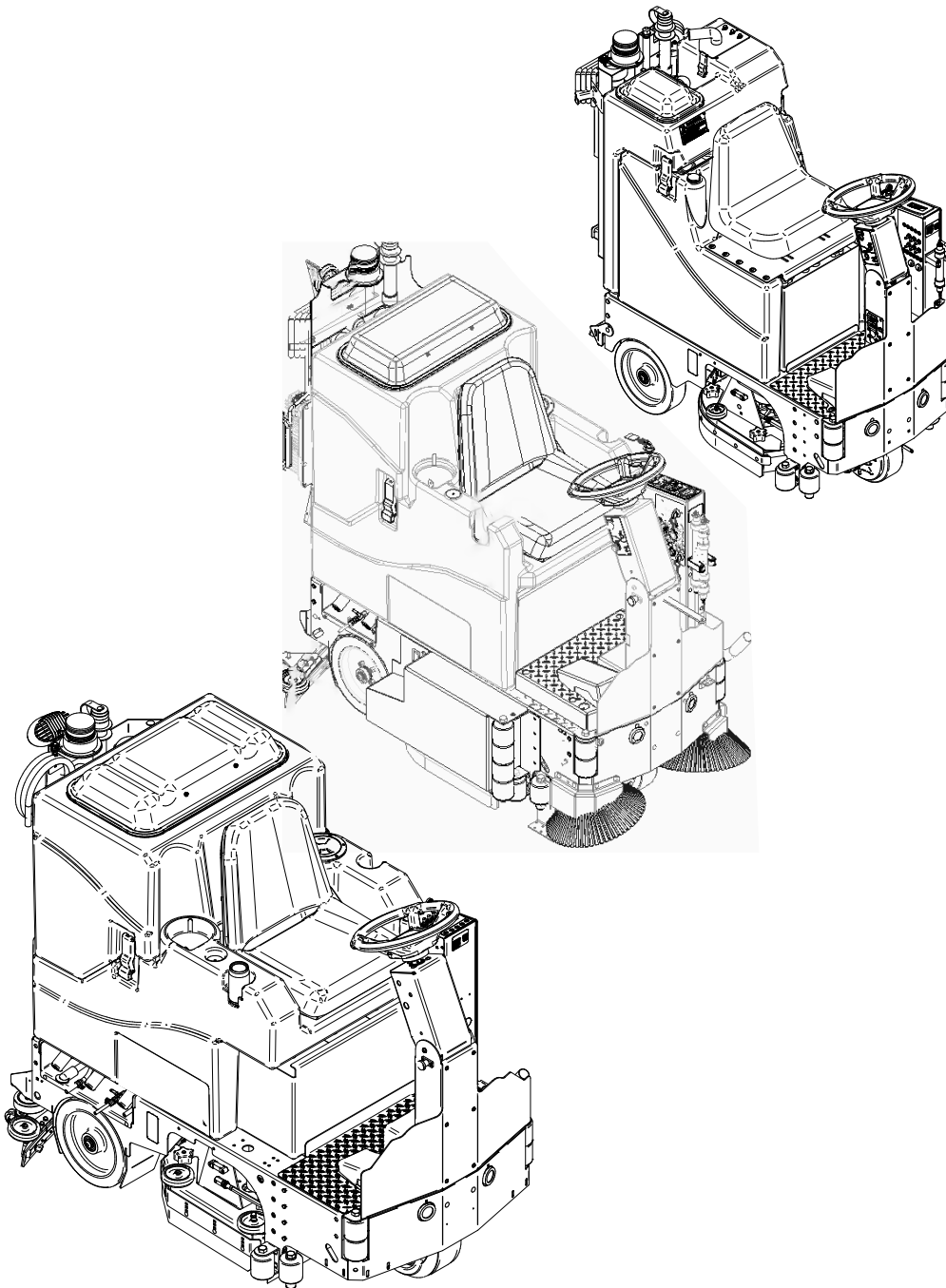

Read these Instructions before using the machine.



Read these Safety Messages before using the machine.

INTRODUCTION

This manual is furnished with each new machine. This manual will allow the Operator to get the best performance out of your RPS manufactured Scrubber-Drier, Sweeper, Burnisher, or Orbital Scrubber. Read this manual thoroughly before operating or servicing the machine.

This machine will provide excellent performance, but the best results will be obtained at the most minimum costs if:

- The machine is regularly maintained - per the Authorized Local Distributor.
- The machine is operated with reasonable care and caution.
- The machine is maintained with manufacturer supplied parts.

LOCATE SERIAL NUMBER

The serial number of your machine is located on the lower half of the steering column of the machine.

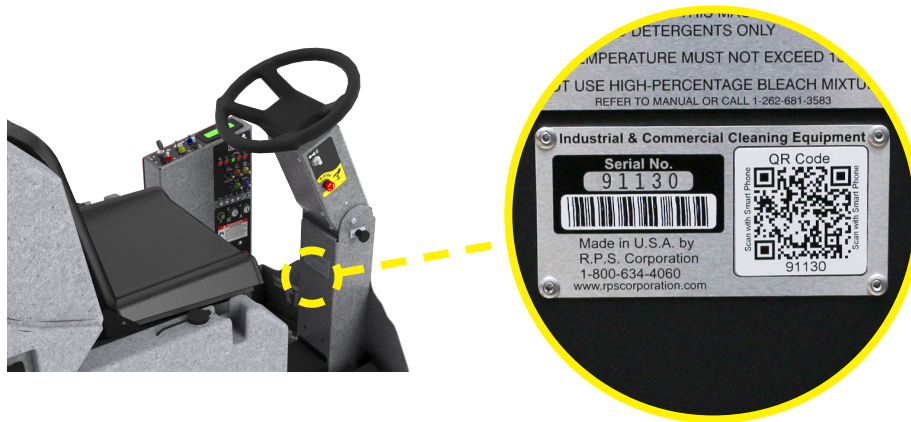

AS OUR POLICY IS ONE OF CONSTANT IMPROVEMENT - ALL INFORMATION AND SPECIFICATIONS ARE SUBJECT TO CHANGE WITHOUT NOTICE.



TABLE OF CONTENTS

Introduction.....	2	Transportation - Reverse.....	29
Locate Serial Number.....	2	Fill Solution Tank.....	30
Table Of Contents.....	3	Operation - Scrubbing.....	31
Safety Messages.....	4	Draining Recovery Tank.....	32
Safety Labels.....	6	Draining Solution Tank.....	33
Central command Dashboard controls (Military, Legacy, Touch Screen).....	7	Flushing Recovery Tank.....	34
Central Command Side Panel Controls.....	8	Clean Drain Saver & Vac System.....	35
Legacy LCD Screen.....	9	Clean Cylindrical Hopper.....	36
Touch Screen (Optional).....	10	Remove Disk Brushes.....	37
Touch Screen Symbols (Optional).....	11	Remove Cylindrical Brushes.....	38
Touch Screen Zone Operation (Optional).....	12	Parking Brake.....	39
Touch Screen Zone Programming (Optional).....	13	Battery Chargers.....	40
LCD Screen.....	14	P&G Controller Common Error Codes.....	41
steering col Controls.....	15	Touch Screen Error Codes.....	42
Service Cabinet.....	16	Touch Screen Error Codes.....	43
Spray Jet Controls (Optional).....	17	Touch Screen Error Codes.....	44
Suds Controls (Optional).....	18	Military - Status Light Codes	45
ZERO3 Controls (Optional).....	19	PM Sheet.....	46
Manager Lock Outs.....	20		
Headlights & Work-lights (Optional).....	21		
Side Broom System (Optional).....	22		
Legacy Econ Switch.....	23		
Battery Setup.....	24		
Remove Squeegee.....	25		
Adjust Side Squeegee.....	26		
Adjust Squeegee.....	27		
Transportation - Forward.....	28		

SAFETY MESSAGES



You will see four kinds of safety reminders in this manual:

DANGER

DANGER indicates a hazardous situation which, if not avoided, will result in death or serious injury.

CAUTION

CAUTION indicates a potentially hazardous situation which, if not avoided, could result in minor or moderate injury or damage to this machine or nearby objects. CAUTION also can be used to alert against unsafe practices.

WARNING

WARNING indicates a potentially hazardous situation which, if not avoided, could result in death or serious injury.

NOTICE

NOTICE indicates information considered important, but not hazard-related. This safety message may be related to property damage or warranty warnings.

Your safety, and that of others, is very important. Operating this machine safely is an important responsibility.

DO NOT OPERATE THIS MACHINE:

- Unless you are trained and authorized to do so by your RPS Authorized Local Distributor
- Unless you have read and understood this Operator's Manual
- On surfaces with greater than a 2% / 3.49° grade
- On Loading Docks

WHEN OPERATING THIS MACHINE:

- Remove loose objects from the floor that could be projected from the rotating Brushes
- Keep your hands and feet away from the rotating Brushes
- Do not operate this machine where flammable liquids, vapors, or dust are present
- Use caution when maneuvering
- Wear PPE

BEFORE LEAVING THE MACHINE:

- Drain "clean" Solution & "dirty" Recovery solution into APPROVED drains
- Park the machine on a level surface
- Turn the machine off & remove key

BEFORE SERVICING THE MACHINE:

- Disconnect the Batteries
- Wear PPE

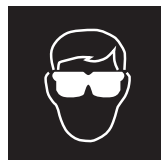
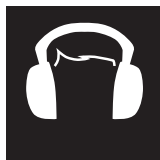

DANGER

Explosive hydrogen gas forms when Batteries are charging. An open flame or spark can cause this gas to explode. Serious personal injury or property damage could occur. Only charge the Batteries in this machine in a well ventilated area.

DANGER

Flammable materials can cause an explosion or fire. Do not use flammable materials in Tank or pick up.

! WARNING

The Batteries in this machine produce hazardous voltage which can cause electrical shock, burns and/or electrocution. Always disconnect Batteries before servicing this machine.

! WARNING

When climbing or descending ramps, always drive machine forward. To avoid overturning the machine, Do not back down ramps. Do not drive across inclines. Do not turn while ascending or descending ramps. Overturning the machine can cause serious injury or death.

! WARNING

Do not use water that exceeds 130°F / 54°C. If water is above said temperature, this will void the Tank Warranty.

! WARNING

Do not park this machine on ramps or slopes. Always park this machine on a level, hard surface. Do not operate this machine outdoors or on uneven surfaces.

! WARNING

The Batteries in this machine contain sulfuric acid, which causes burns to skin. If battery acid contacts clothing or skin, rinse the effected area with cold water immediately. If battery acid gets on your face or in your eyes, flush the area immediately with cold water and seek medical attention.

! WARNING

To avoid electrical shock, do not operate this machine over electrical floor outlets.

! CAUTION

To avoid damage to this machine, use only cleaning solutions and replacement parts recommended by the manufacturer.

! CAUTION

Do not operate this machine if any parts have been damaged or removed.

! WARNING

Dress safely. Do not wear rings or metal wrist watches when servicing this machine, as they can cause an electrical short circuit which can cause serious burns.

! WARNING

Do not remove, paint over or destroy warning decals. If warning decals become damaged, call 1-262-681-3583 for free replacements.

! WARNING

Dress safely. Do not wear a neck tie, scarf, or any loose or dangling clothing while operating this machine. Loose or dangling clothing or neck-wear can tangle in rotating parts, causing serious injury or death.

! WARNING

Always turn off this machine before leaving it unattended. Do not allow untrained persons to operate this machine.

! WARNING

NO RIDERS. Do not carry passengers on this machine. Do not use this machine as a stepladder or work platform.

! WARNING

Understand the dynamic braking system before you operate the machine on ramps. Machine may coast.

! WARNING

Before you service a Battery, always wear face protection, protective gloves and protective clothing. Battery acid or battery explosion can cause serious injuries.

! CAUTION

Always use the automatic battery charger provided by the manufacturer of this machine to charge the Batteries of this machine. It is designed to charge the Batteries at the appropriate rate. If you must use a different charger, disconnect the Batteries before charging to avoid damage to the electronic speed controller.

! CAUTION

To avoid damage to the electronic control components of this machine, Do not store this machine outdoors. Do not pressure wash this machine.

SAFETY LABELS



Read and obey all Safety Labels on your equipment. If you have questions about these labels, ask your supervisor. These images indicate where on the Safety Labels are located. If ever the labels become illegible, worn off, or torn, promptly report it to your supervisor and replace it.

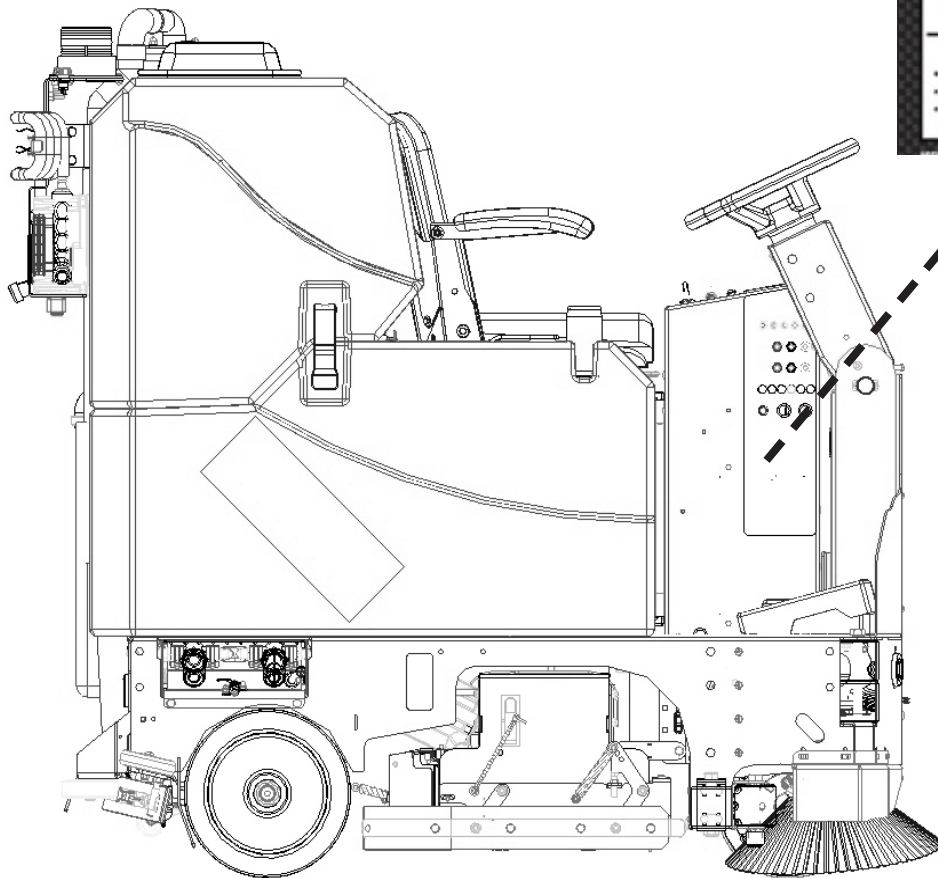

CENTRAL COMMAND DASHBOARD CONTROLS (MILITARY, LEGACY, TOUCH SCREEN)

Military Grade

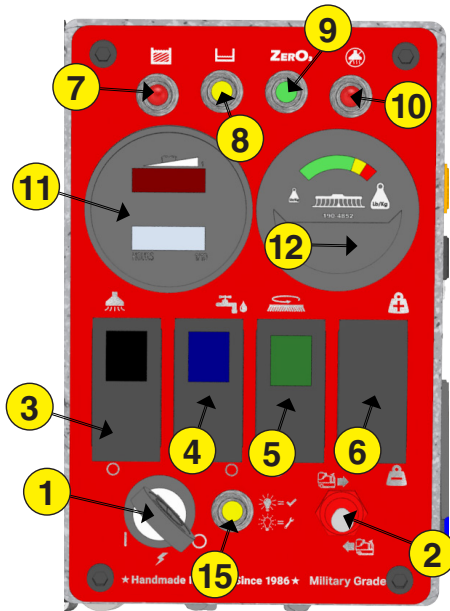

Legacy

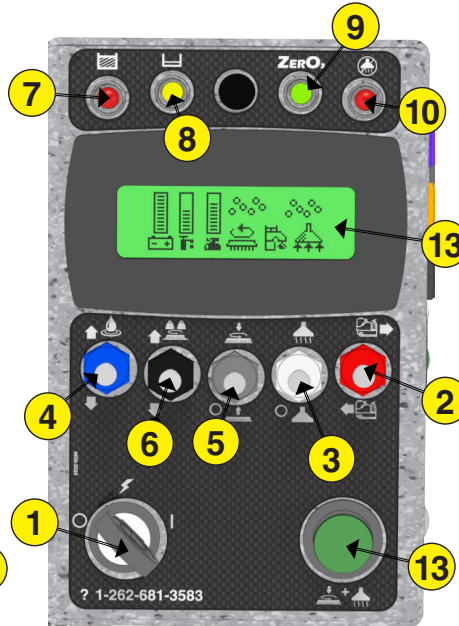

Touch Screen



1. Key Switch On (I) / Off (O)
2. Reverse Switch
3. Vac Switch
4. Solution Switch
5. Scrubdeck Switch
6. Down pressure Switch
7. Full Recovery Tank Light
8. Empty Recovery Tank Light
9. ZERO3 Light
10. Vac Clog Light
11. Military Battery Gauge / Hour Meter Combo
12. Military Down Pressure Gauge
13. Legacy LCD Screen
14. Legacy Quick Start Button
15. Status Indicator Light

Military Grade

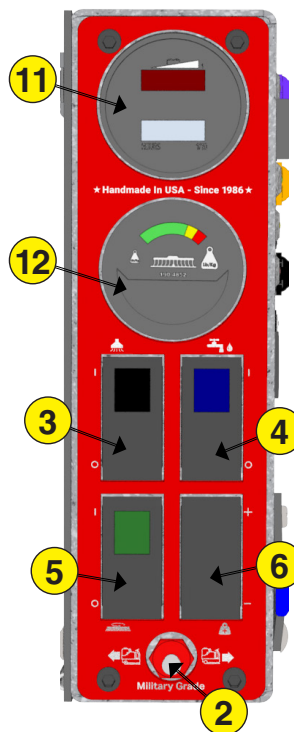

Legacy

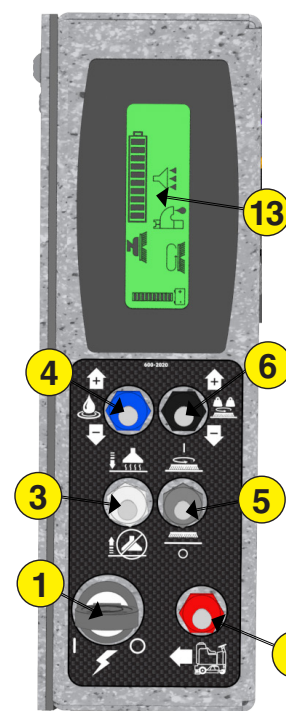

Touch Screen

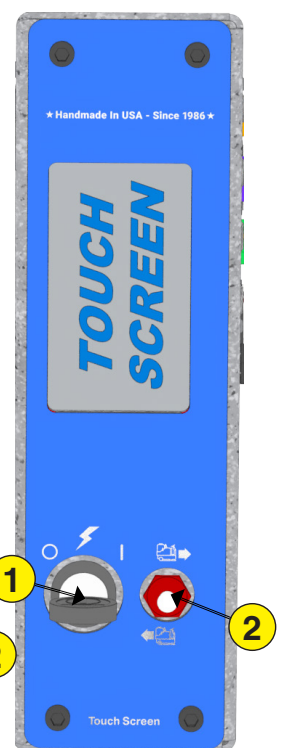

CENTRAL COMMAND SIDE PANEL CONTROLS

Military Grade (EX)

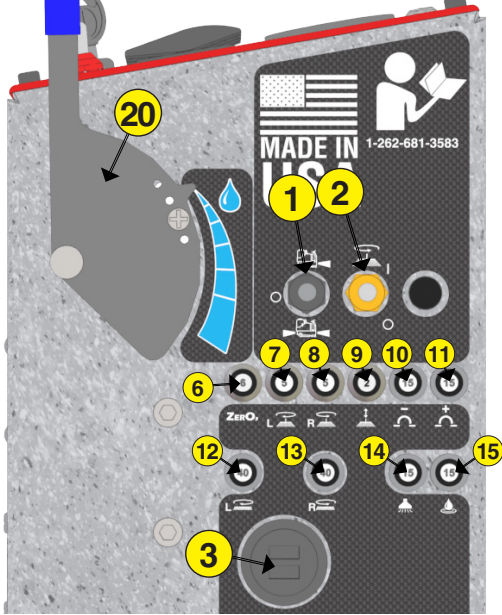

Legacy (EX)

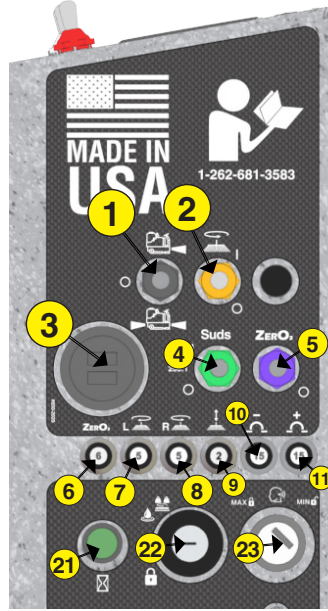

Touch Screen (EX)



Military Grade (Pro/CRZ)

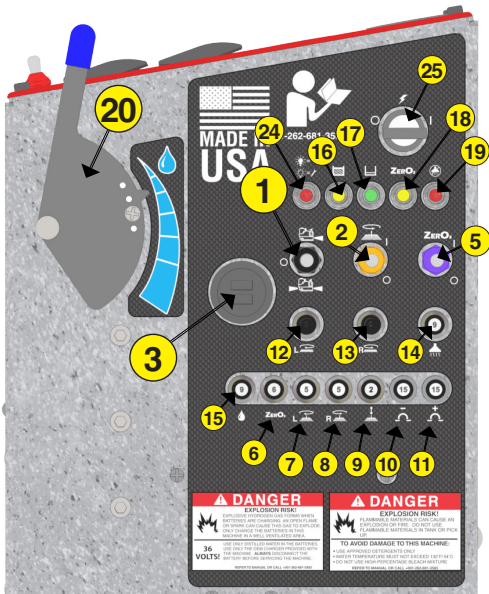

Legacy (Pro/CRZ)



Touch Screen (Pro/CRZ)



1. Head Lights/ Tail Lights
2. Side Brooms On (I) / Off (O)
3. Dual USB Voltmeter
4. Suds Switch 125:1/ 250:1/ Off (O)
5. ZER03 On (I) / Off (O)
6. ZER03 Circuit Breaker
7. Left Side Broom Circuit Breaker
8. Right Side Broom Circuit Breaker
9. Side Broom Lift Circuit Breaker

10. Negative BUSS Circuit Breaker
11. Positive BUSS Circuit Breaker
12. Left Brush Circuit Breaker
13. Right Brush Circuit Breaker
14. Vac Circuit Breaker
15. Solution Valve Circuit Breaker
16. Full Recovery Tank Indicator Light
17. Empty Solution Tank Indicator Light
18. ZER03 Indicator Light
19. Vac Indicator Light

20. Solution Control Lever
21. Hour Meter Button
22. Dual Manager Lockout Solution/Downpressure
23. ECON switch Max (locked) Min (unlocked)



LEGACY LCD SCREEN

SCREEN #1 (OPERATOR)

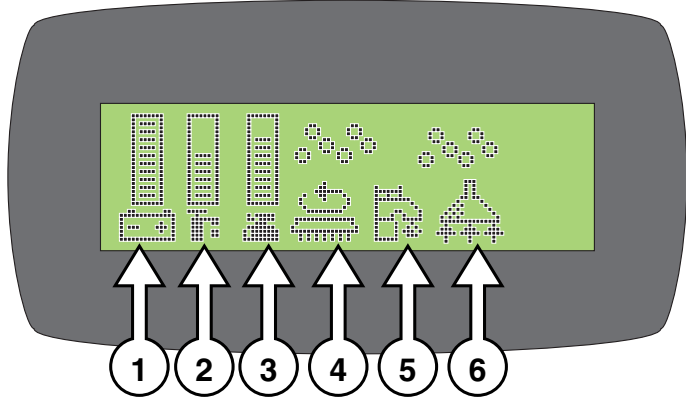

SCREEN #2 (MAINTENANCE)

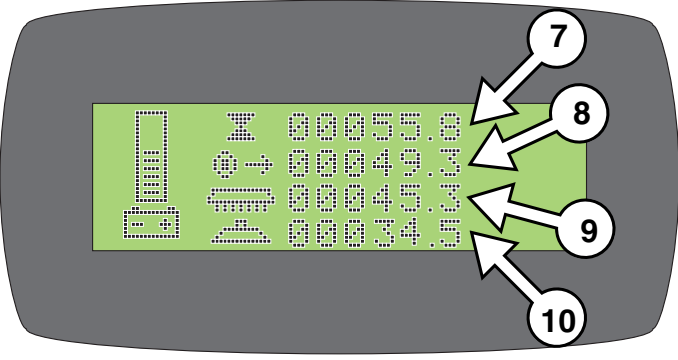

SCREEN #3 (WITH ERROR CODE)

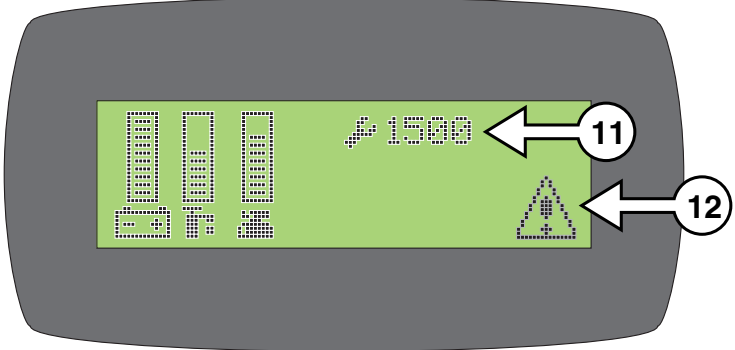

**** USE GREEN MENU SELECTION BUTTON ON CONTROL PANEL TO CHANGE SCREENS ****

- 1. **BATTERY LEVEL INDICATOR** - Indicates the energy level remaining in the Batteries (*Shown on all menu displays*)
- 2. **SOLUTION OUTPUT INDICATOR** - Indicates the gallons per minute (*GPM*) 0 - 1.0
- 3. **SCRUBDECK DOWN PRESSURE INDICATOR** - Sets the down pressure on the Brushes / Pads
- 4. **SCRUB MOTORS ON** - Indicates the Brush Motors are in operation
- 5. **SOLUTION ON** - Indicates the solution flow is *ON*
- 6. **VACUUM ON** - Indicates the Vacuum is *ON*
- 7. **KEY SWITCH HOUR METER** - Indicates total hours the machine has had keyswitch *ON*
- 8. **TRANSPORT HOUR METER** - Indicates total hours the drive system has been in operation
- 9. **SCRUB BRUSH HOUR METER** - Indicates total hours the brush motors have been in operation
- 10. **VACUUM HOUR METER** - Indicates total hours the vacuum motor has been used
- 11. **DIAGNOSTIC CODE** - Displays diagnostic code which helps troubleshoot issues
- 12. **ERROR WARNING SYMBOL** - Indicates when there has been a diagnostic code error

TOUCH SCREEN (OPTIONAL)

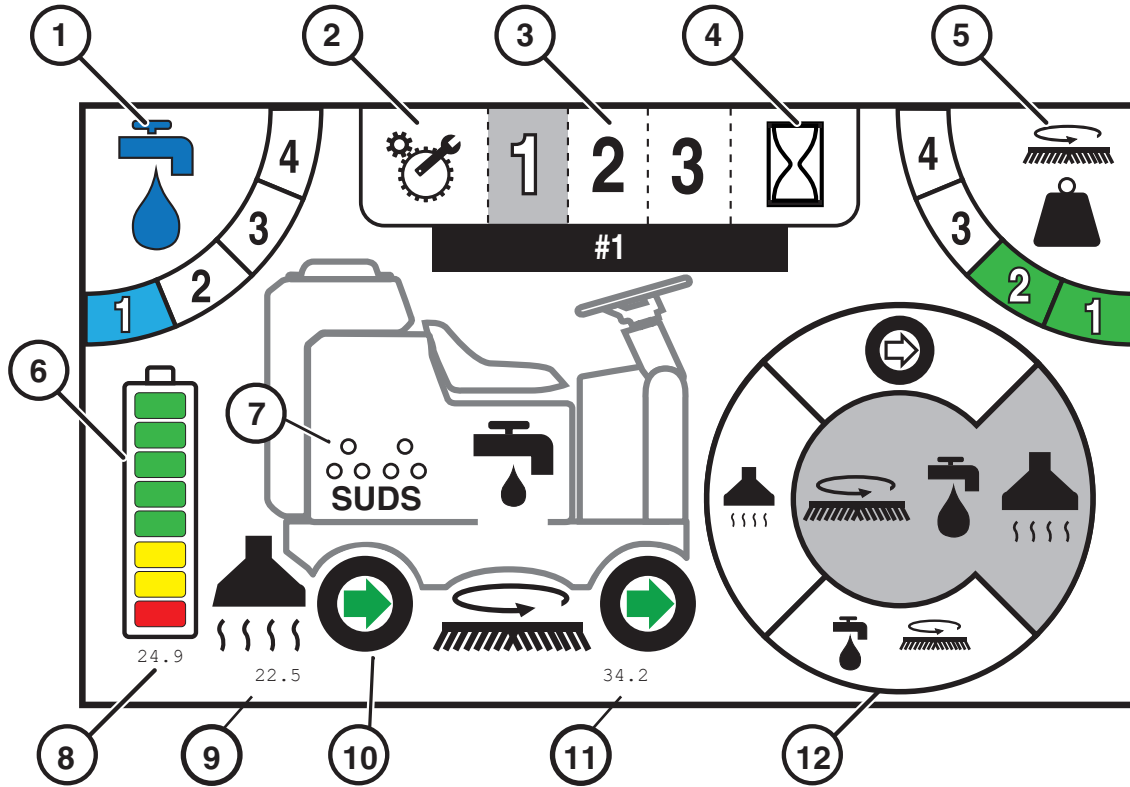
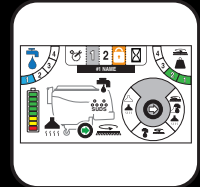

1. **SOLUTION OUTPUT** - Indicates the level of solution that is being dispensed when in operation, (0 = off, 1 = Low, 4 = High).
2. **TECHNICAL / MANAGER SETUP** - Access 'Error Code History' and Manager Programming
3. **PROGRAMMED ZONES** - Switch between preset solution and downpressure settings for varying applications
4. **HOUR METERS** - Displays all of the hour meters of the machine: Key Switch, Transport, Scrub Motors, and Vacuum Motor
5. **DOWN PRESSURE OUTPUT** - Indicates the level of downpressure that is being applied to the floor surface (1 = low, 4 = high).
6. **BATTERY GAUGE** - Indicates the level of battery charge available and volt meter
7. **SUDS** - (Onboard Chemical Dilution) indicator
8. **ACTIVE VOLT & AMP DRAW** - Indicates the live DC Volts (under battery gauge) and Amp draw (under systems) when machine is running
9. **AMP VAC CURRENT** - Indicates Vac power consumption
10. **TRANSPORT INDICATION** - Green Forward & Red Rev
11. **BRUSH DISK CURRENT** - Indicates Brush power consumption
12. **OPERATION MODE SELECTOR** - Cycle through and select which operation mode you would like to work in

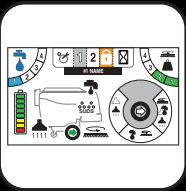

TOUCH SCREEN SYMBOLS (OPTIONAL)

Mode Selection

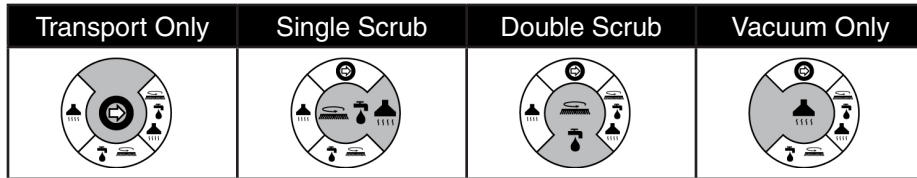

Solution Setting

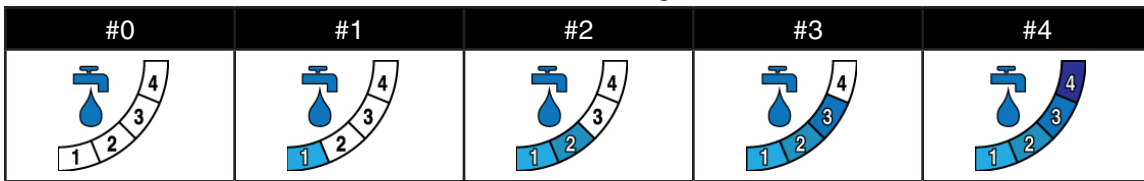

Down Pressure Setting

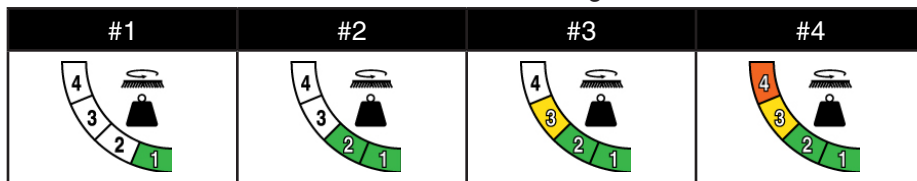

Forward Transport Motor

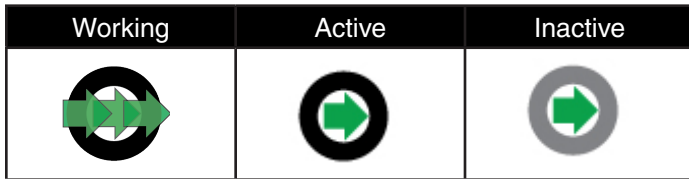

Reverse Transport Motor



Solution Flow

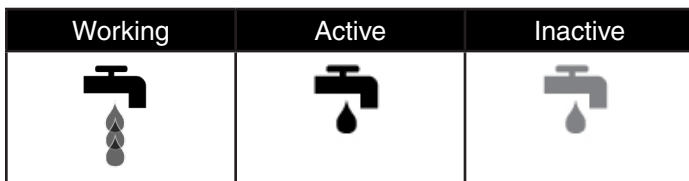

Vacuum Motor

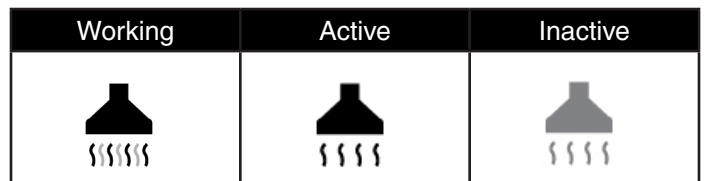

Suds

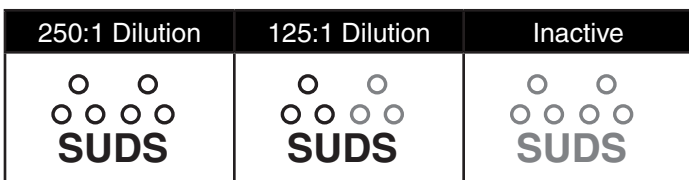

Scrub Deck Motor(s)

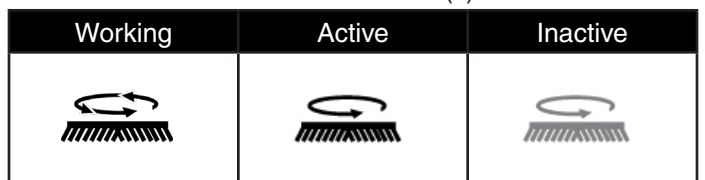

Setup



Hour Meters



Zone Lock

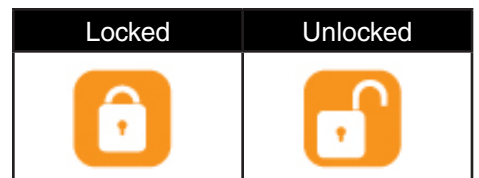

TOUCH SCREEN ZONE OPERATION (OPTIONAL)

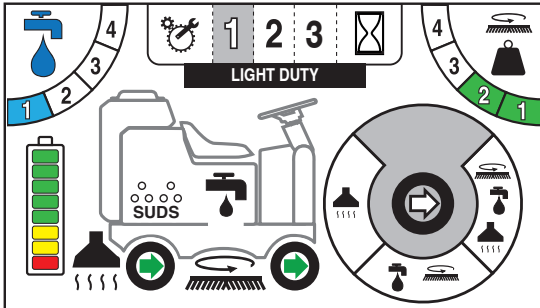

The touch screen is designed to be programmed to three specific zones. Each zone can be named and custom programmed or even disabled if not needed.

The zone you are working in is highlighted as indication. In Figure 1. the zone selected is Light Duty.

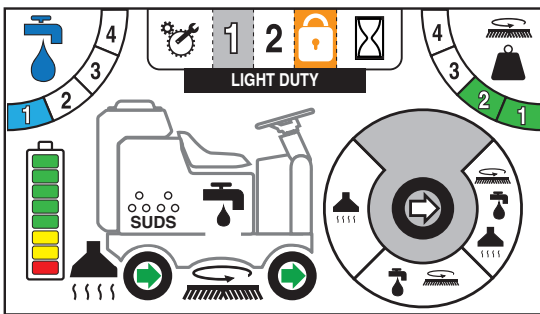

Figure 2. shows Zone 3 “locked out” by the indicator lock icon.

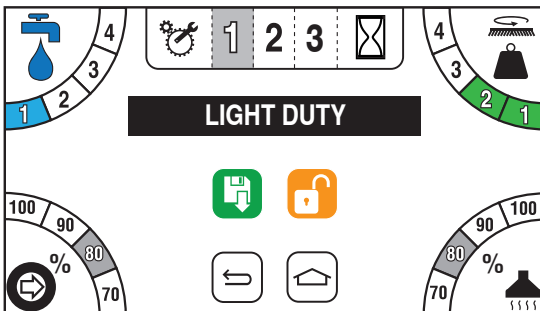

Figure 3. shows Zone 1 “Light Duty” Factory Configuration.

- Water = 1
- Downpressure = 2
- Drive Speed = 70%
- Vac Motor = 80%

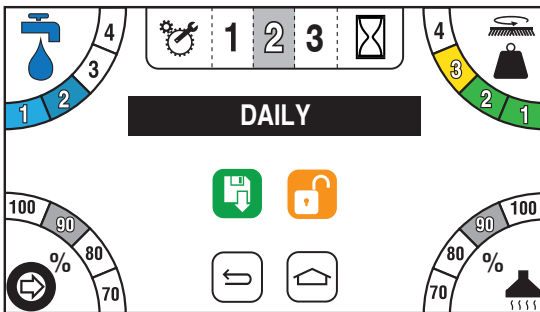

Figure 3. shows Zone 2 “Daily” Factory Configuration.

- Water = 2
- Downpressure = 3
- Drive Speed = 90%
- Vac Motor = 90%

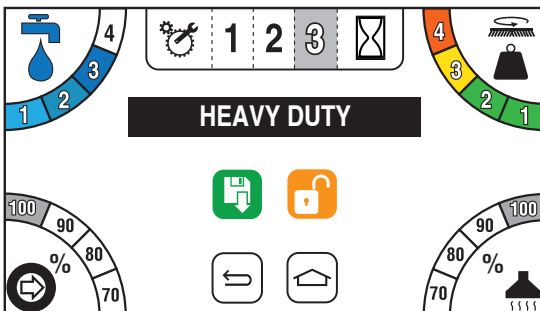
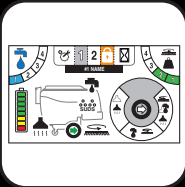
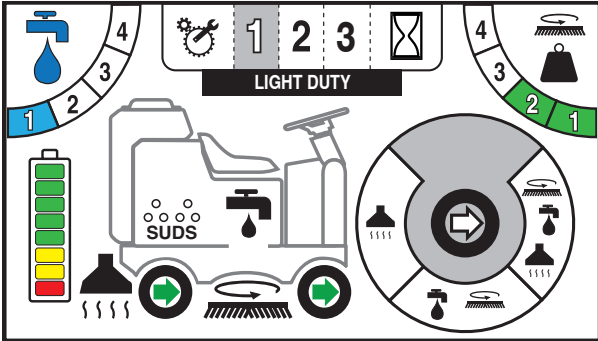

Figure 3. shows Zone 3 “Heavy Duty” Factory Configuration.

- Water = 3
- Downpressure = 4
- Drive Speed = 100%
- Vac Motor = 100%



TOUCH SCREEN ZONE PROGRAMMING (OPTIONAL)



To program the 3 Zones, press

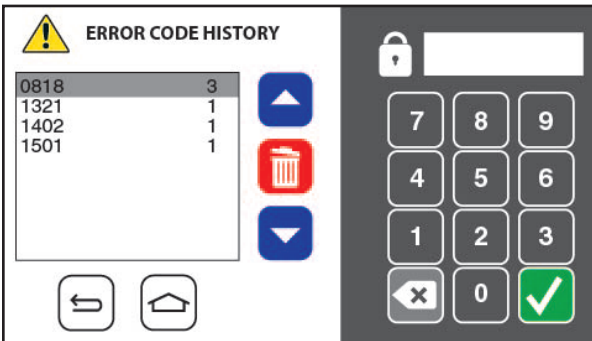

From here you will be prompted with a passcode screen. Enter the manager passcode 349 to get access to setup.

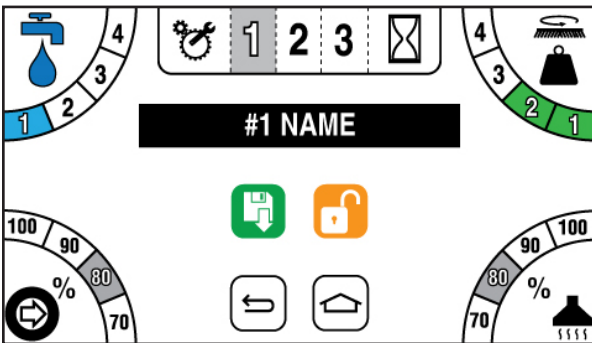

Once you have entered the password, you will see the Figure 3. screen where you can alter the name, solution output, down-pressure setting, scrubbing speed, and vacuum power.

Alternatively you can lock the Zone out from this screen, to prohibit operator use.

Once any of the 3 “Zones” is locked the remaining zones are no longer adjustable either by the operator.



To alter the name of a Zone, simply click on the black name box and a full keyboard will appear as Figure 4. shows. Enter new name and save your work with the Green save icon. 

LCD SCREEN



SCREEN #1 (OPERATOR)

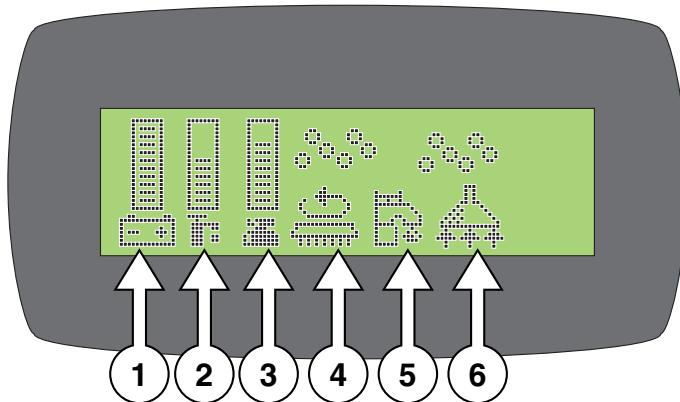

SCREEN #2 (MAINTENANCE)

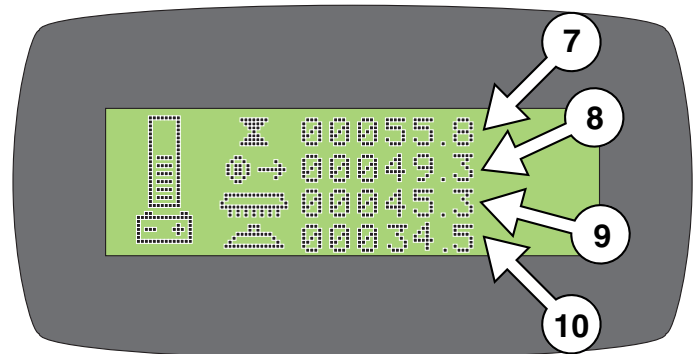

SCREEN #3 (WITH ERROR CODE)

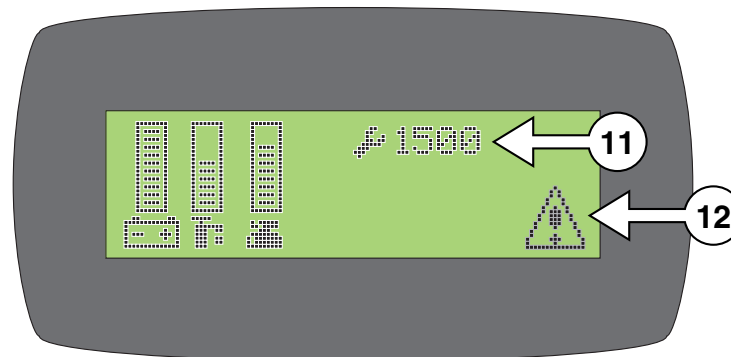

**** USE GREEN MENU SELECTION BUTTON ON CONTROL PANEL TO CHANGE SCREENS ****

1. **BATTERY LEVEL INDICATOR** - Indicates the energy level remaining in the Batteries (*Shown on all menu displays*)
2. **SOLUTION OUTPUT INDICATOR** - Indicates the gallons per minute (*GPM*) 0 - 1.0
3. **SCRUBDECK DOWN PRESSURE INDICATOR** - Sets the down pressure on the Brushes / Pads
4. **SCRUB MOTORS ON** - Indicates the Brush Motors are in operation
5. **SOLUTION ON** - Indicates the solution flow is *ON*
6. **VACUUM ON** - Indicates the Vacuum is *ON*
7. **KEY SWITCH HOUR METER** - Indicates total hours the machine has had keyswitch *ON*
8. **TRANSPORT HOUR METER** - Indicates total hours the drive system has been in operation
9. **SCRUB BRUSH HOUR METER** - Indicates total hours the brush motors have been in operation
10. **VACUUM HOUR METER** - Indicates total hours the vacuum motor has been used
11. **DIAGNOSTIC CODE** - Displays diagnostic code which helps troubleshoot issues
12. **ERROR WARNING SYMBOL** - Indicates when there has been a diagnostic code error









STEERING COL CONTROLS

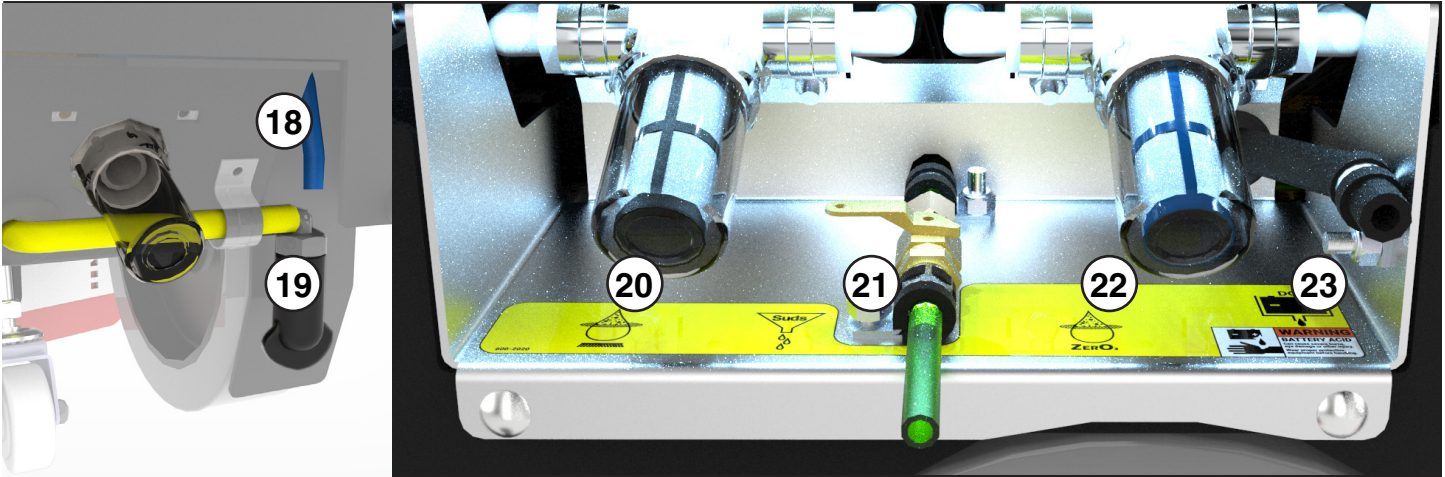

1.	2.	3. EMERGENCY STOP
----	----	--------------------------

SERVICE CABINET



<p>18. VACUUM DISCHARGE: Water passed through the Vacuum Motor will be visible in the reservoir and excess will flow from the blue hose. Indicates service required.</p>		<p>20. SOLUTION FILTER: Standard Solution Feed Filter for scrubdeck.</p> 
<p>21. SUDS DRAIN: Drain detergent from Suds reservoir.</p>		<p>22. ZERO3 FILTER: Optional ZERO3 (O3+) Ozone System Solution Filter.</p> 
		<p>23. BATTERY DRAIN: Drain any fluid from Poly Battery Box.</p> 



SPRAY JET CONTROLS (OPTIONAL)

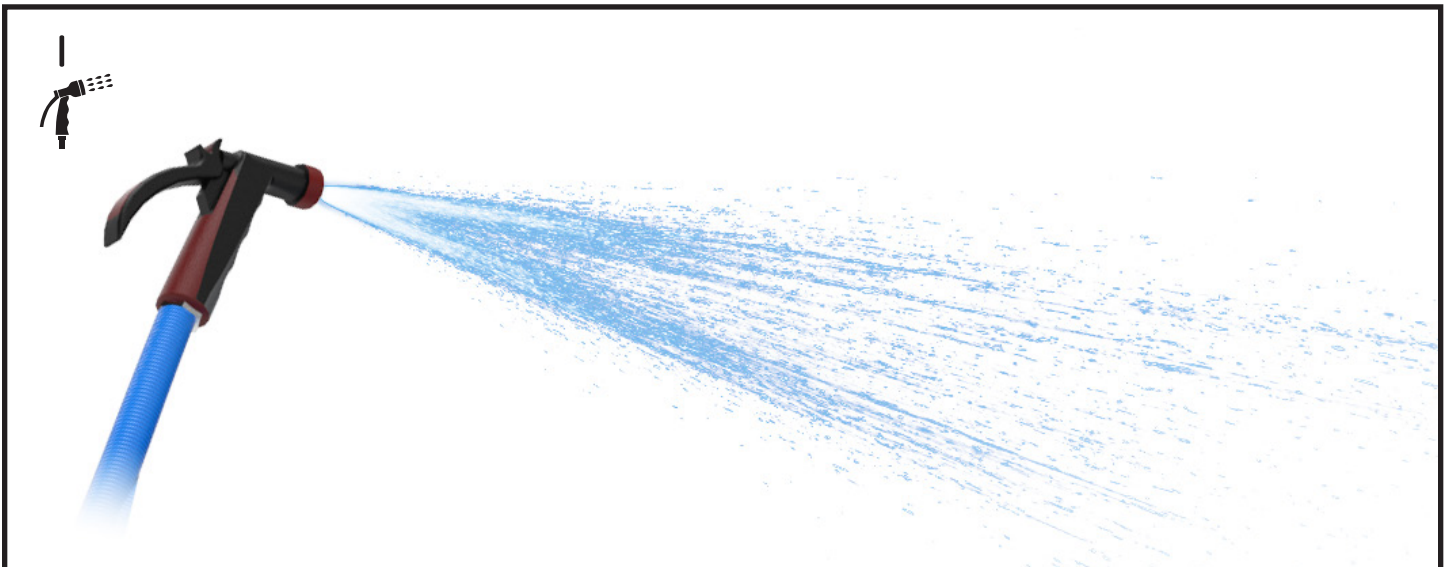
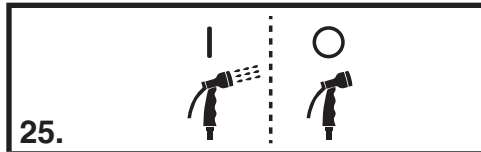

SUDS CONTROLS (OPTIONAL)

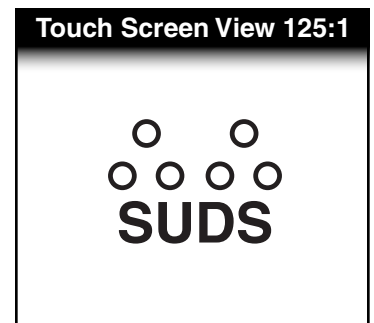
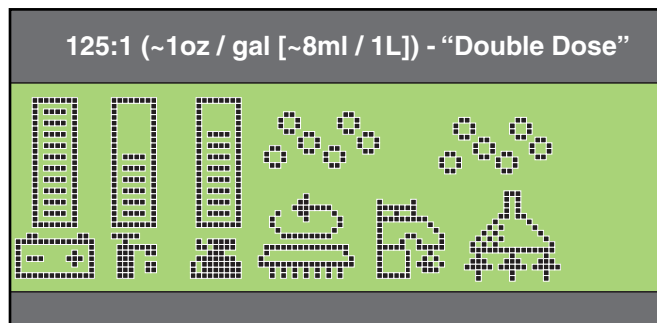
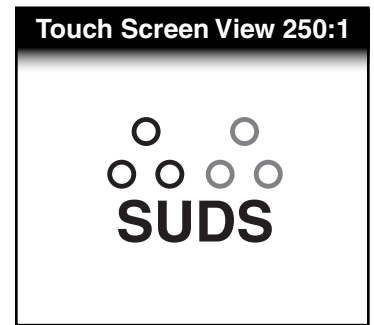
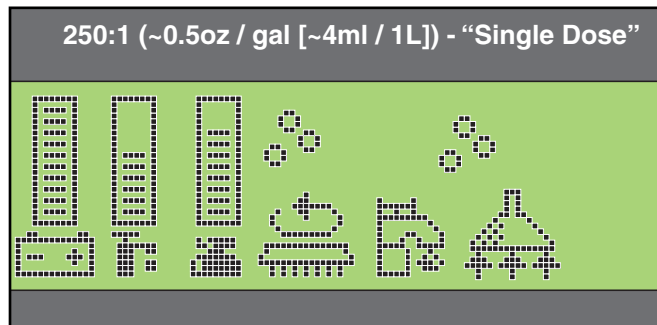
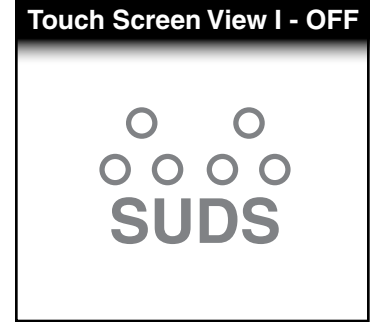
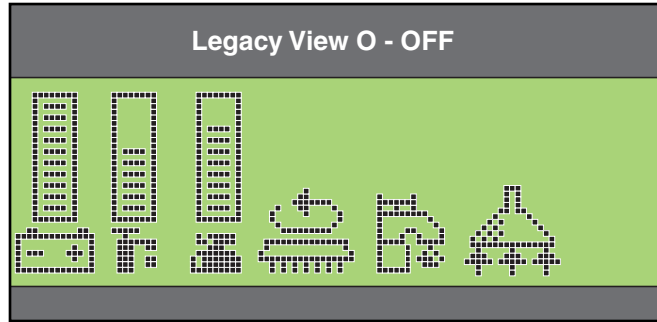
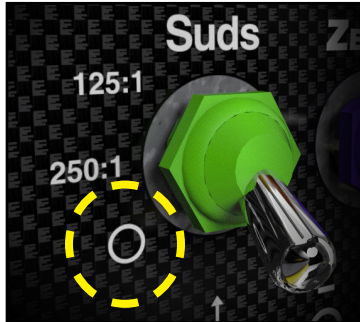
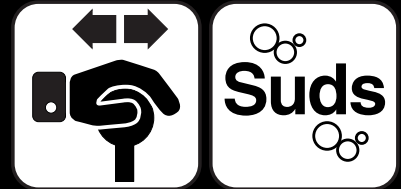

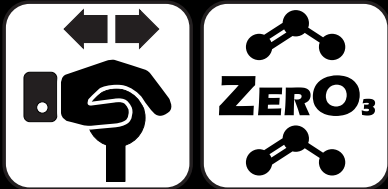

ZERO3 CONTROLS (OPTIONAL)

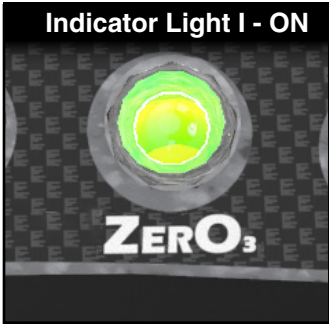
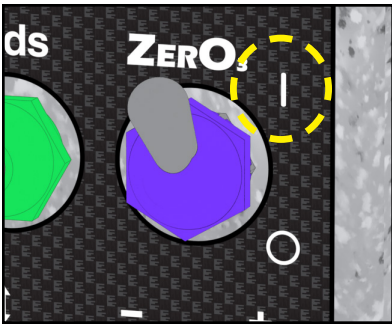
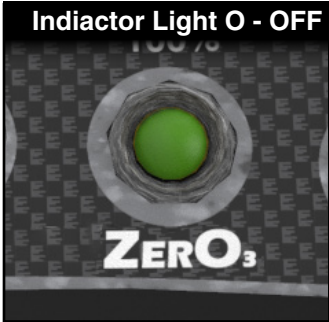
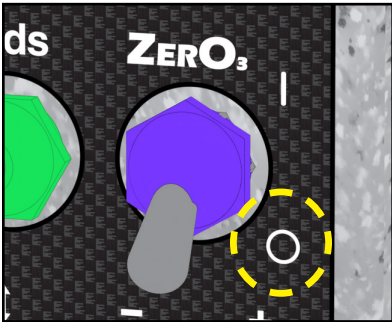

Turn regular solution OFF, when using ZERO3 Aqueous Ozone. Legacy Only

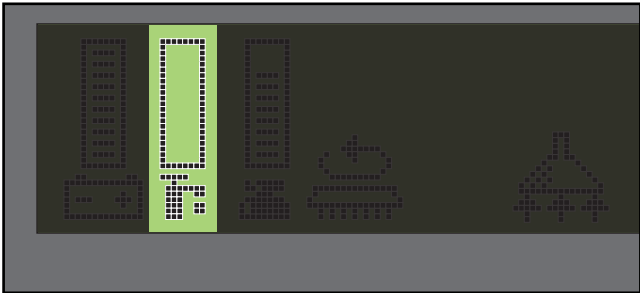

MANAGER LOCK OUTS

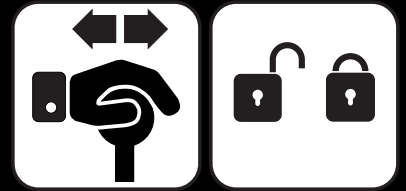

CONTROLLING MANAGER LOCK OUTS:

When the key is in the LOCKED position, keys can be removed and Solution OR Down-pressure cannot be adjusted.

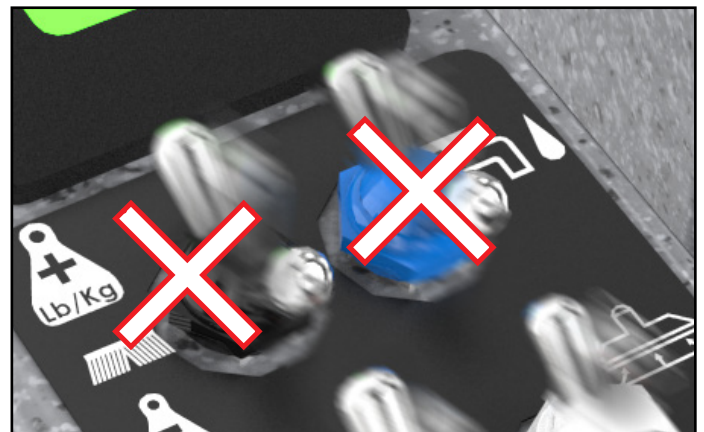
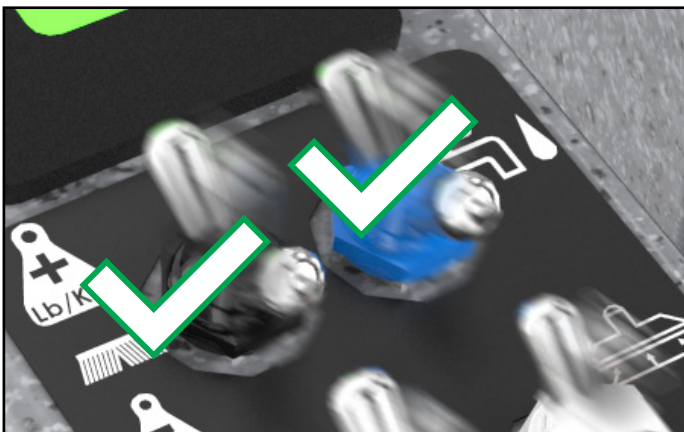
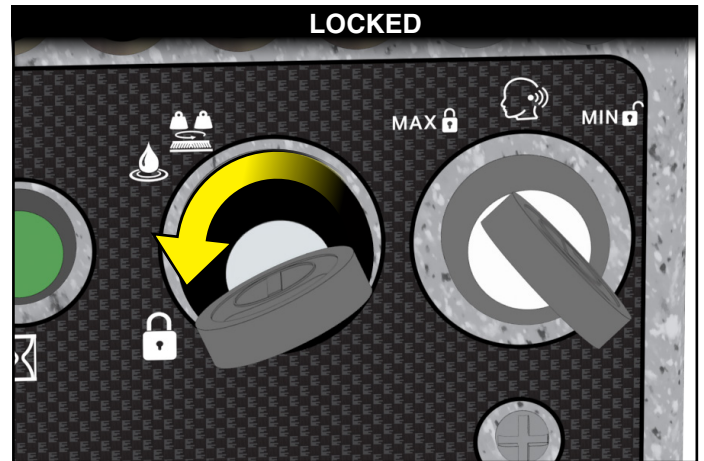

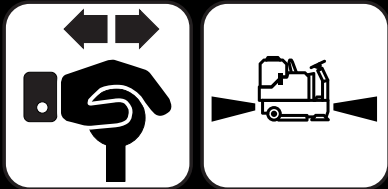

HEADLIGHTS & WORK-LIGHTS (OPTIONAL)

HEADLIGHTS ON

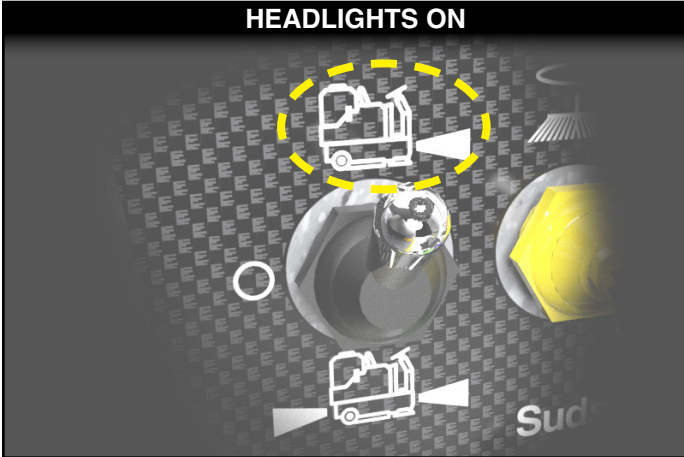

HEADLIGHTS ON

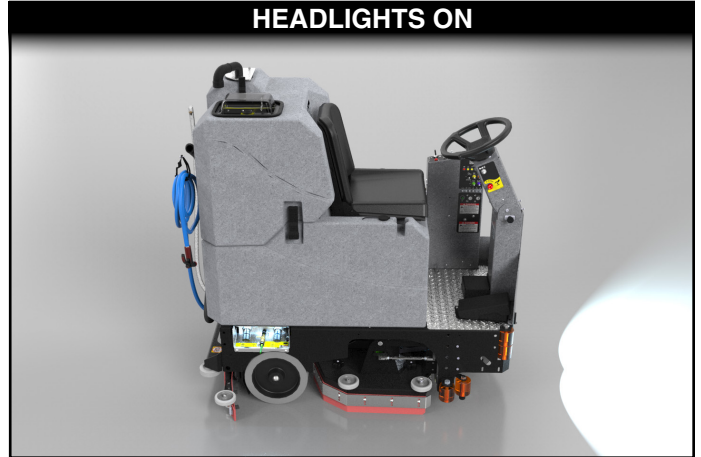

OFF

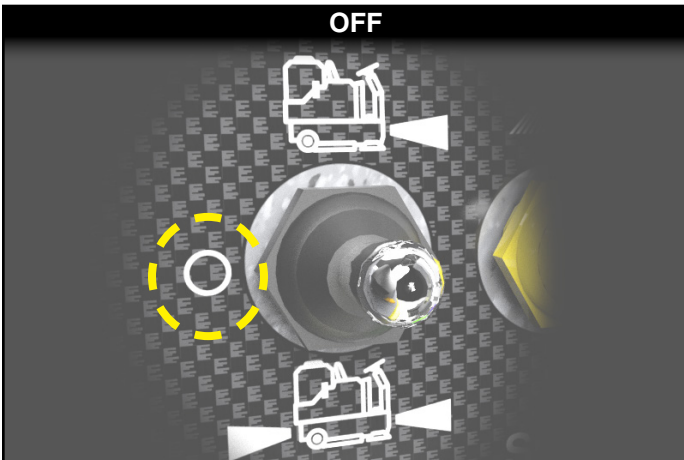

OFF

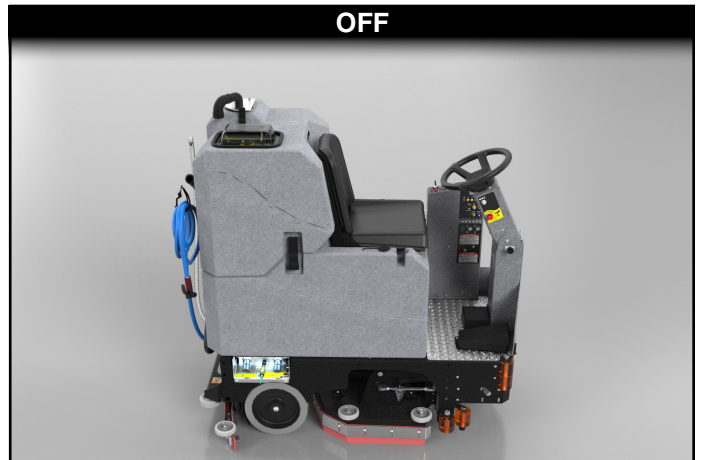

HEADLIGHTS & REAR WORK-LIGHTS ON

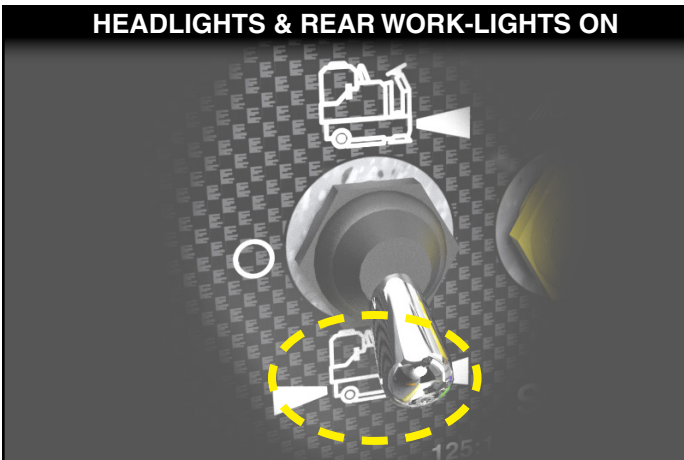

HEADLIGHTS & REAR WORK-LIGHTS ON



SIDE BROOM SYSTEM (OPTIONAL)

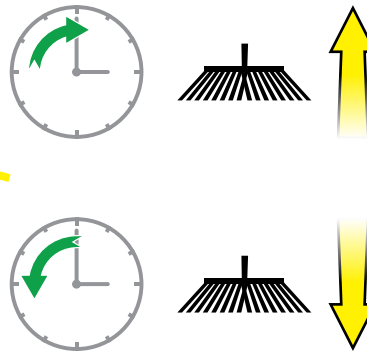
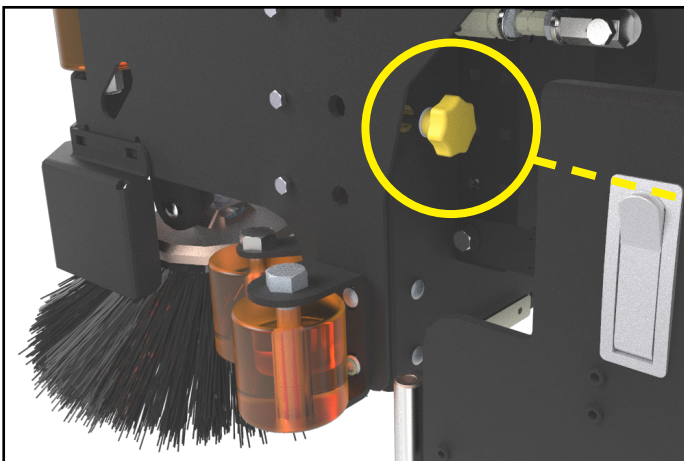
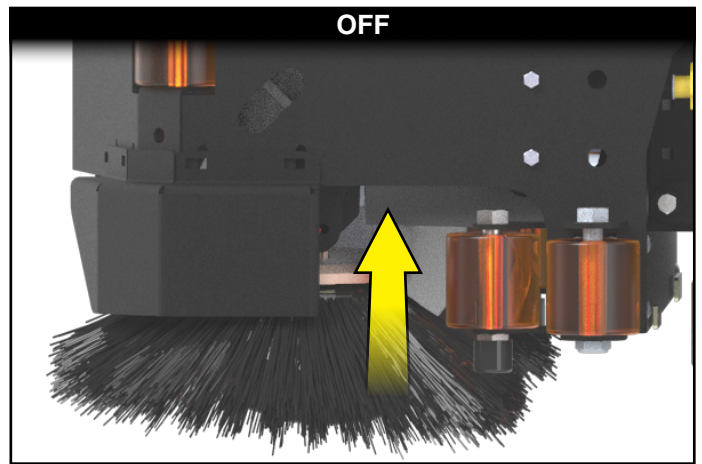
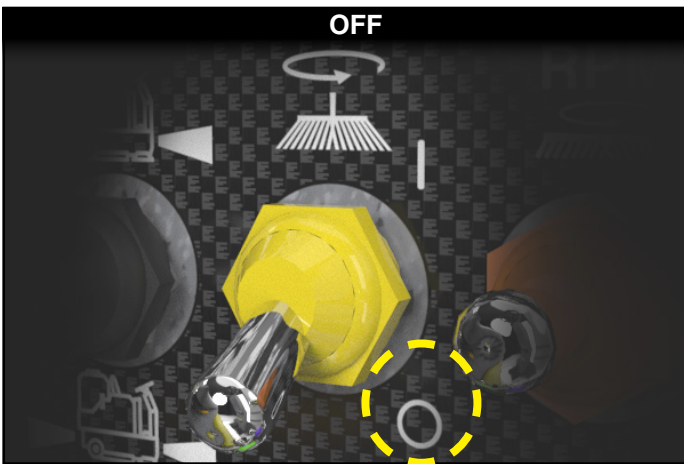
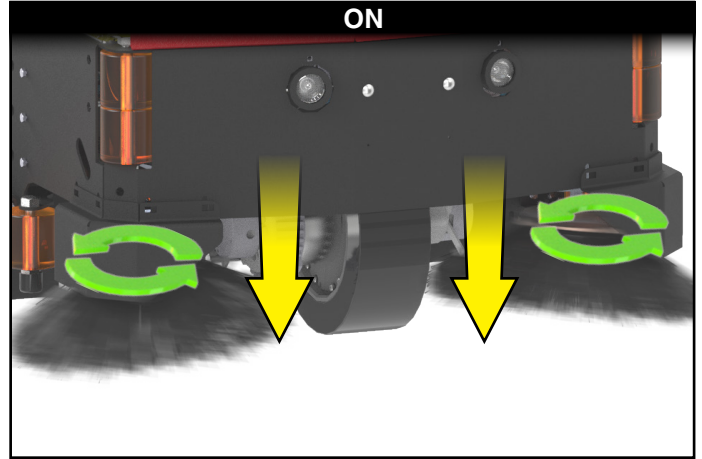
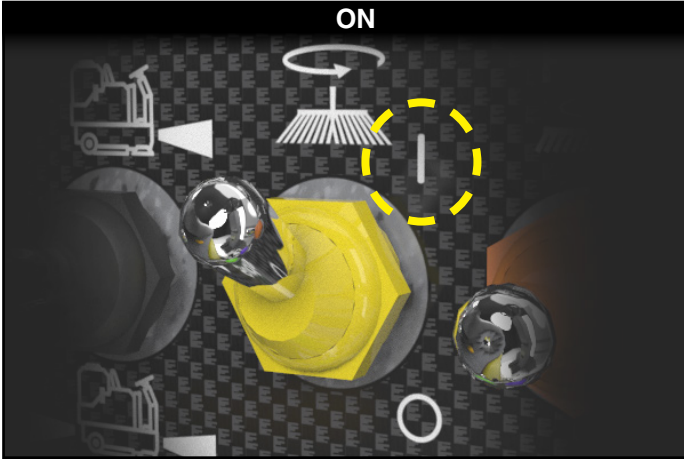
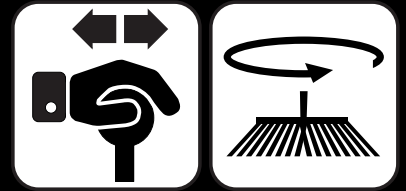

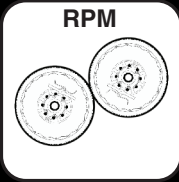

LEGACY ECON SWITCH

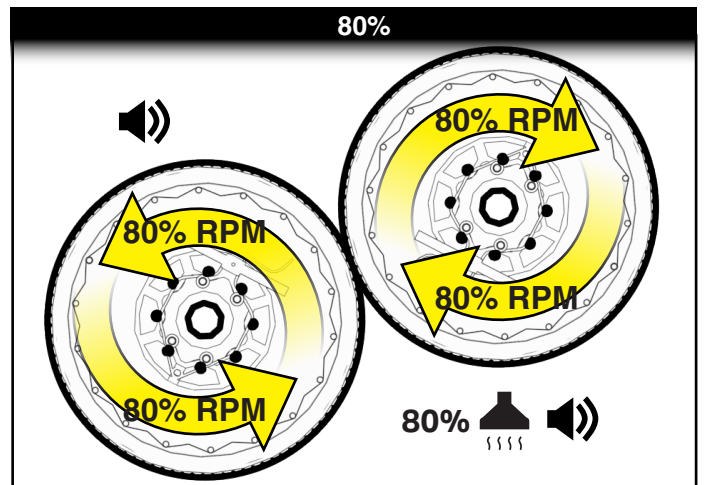
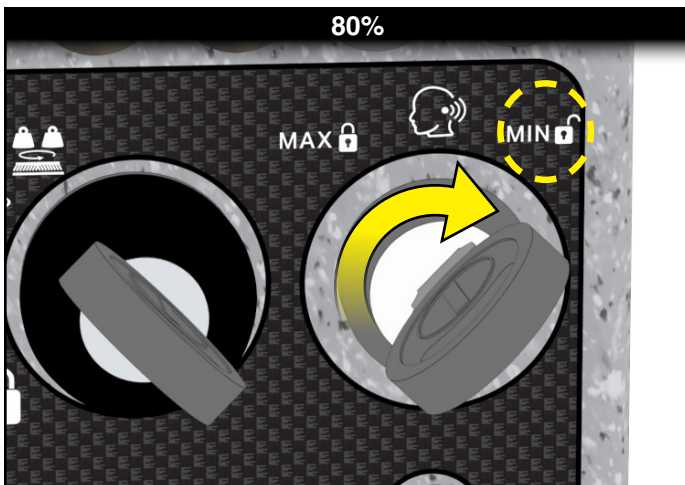
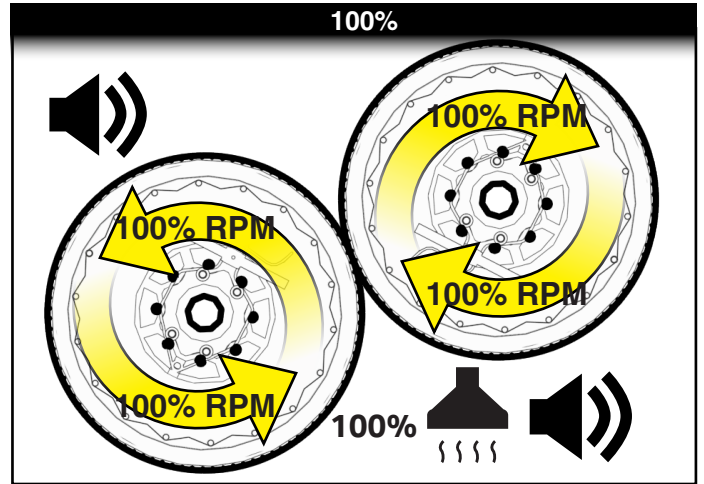
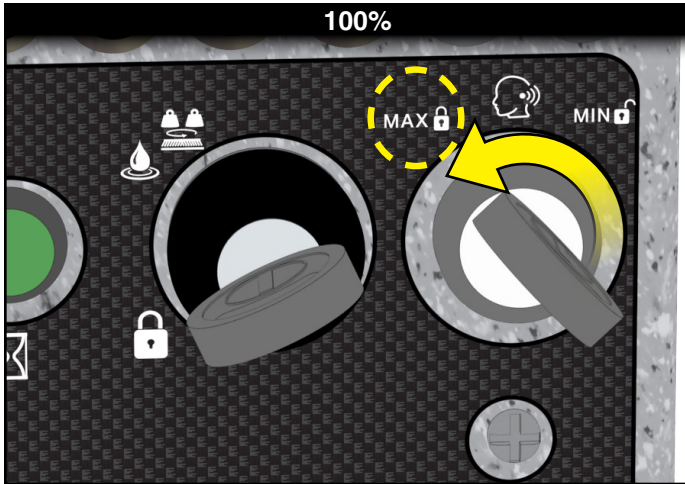

BATTERY SETUP

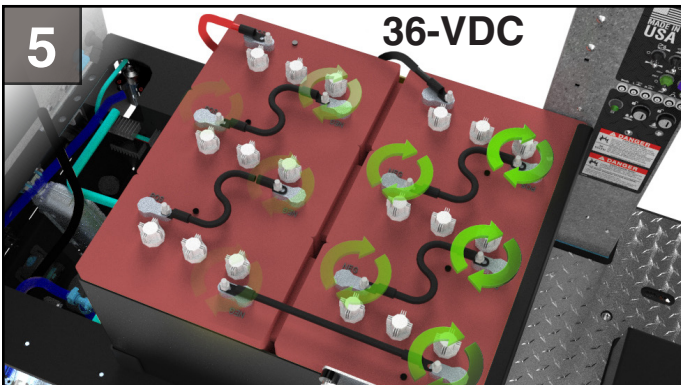
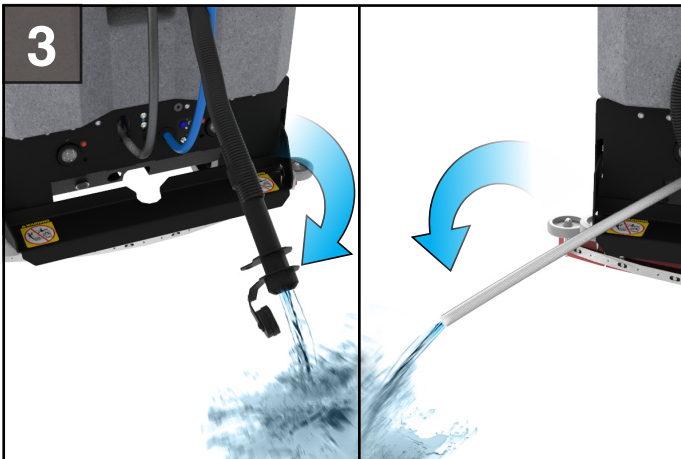
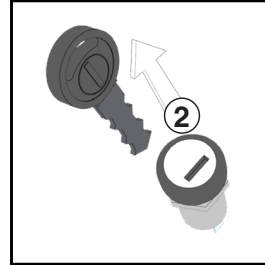
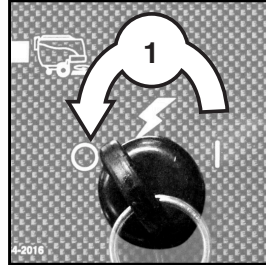
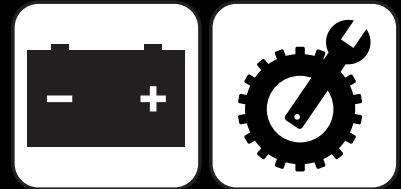

Torque Settings:
8-12 ft/lbs (10.8 - 16.3 Newton-meters)

NOTICE

Batteries are a possible environmental hazard. Consult your Battery supplier for safe disposal methods.

⚠ WARNING

Before you service a Battery, always wear face protection, protective gloves and protective clothing. Battery acid or battery explosion can cause serious injuries.



⚠ WARNING

The Batteries in this machine contain sulfuric acid, which causes burns to skin. If battery acid contacts clothing or skin, rinse the effected area with cold water immediately. If battery acid gets on your face or in your eyes, flush the area immediately with cold water and seek medical attention.



REMOVE SQUEEGEE

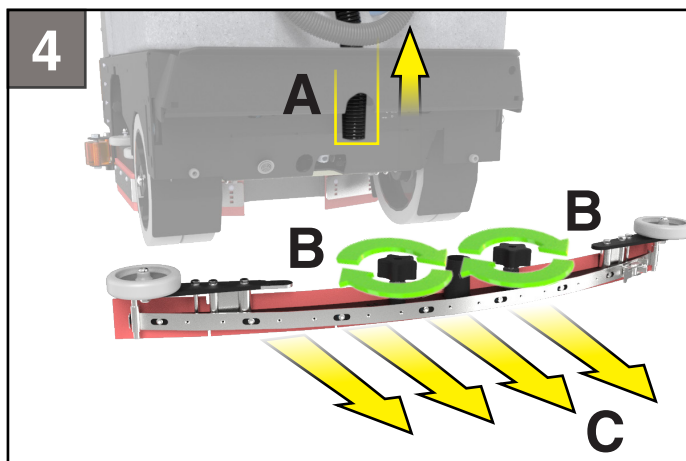
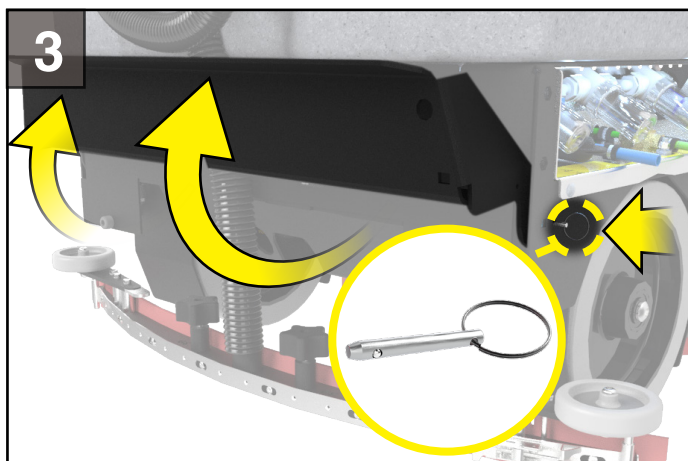
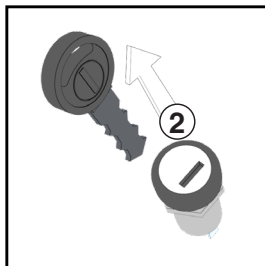
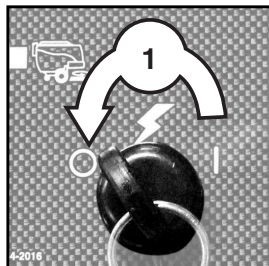

ADJUST SIDE SQUEEGEE

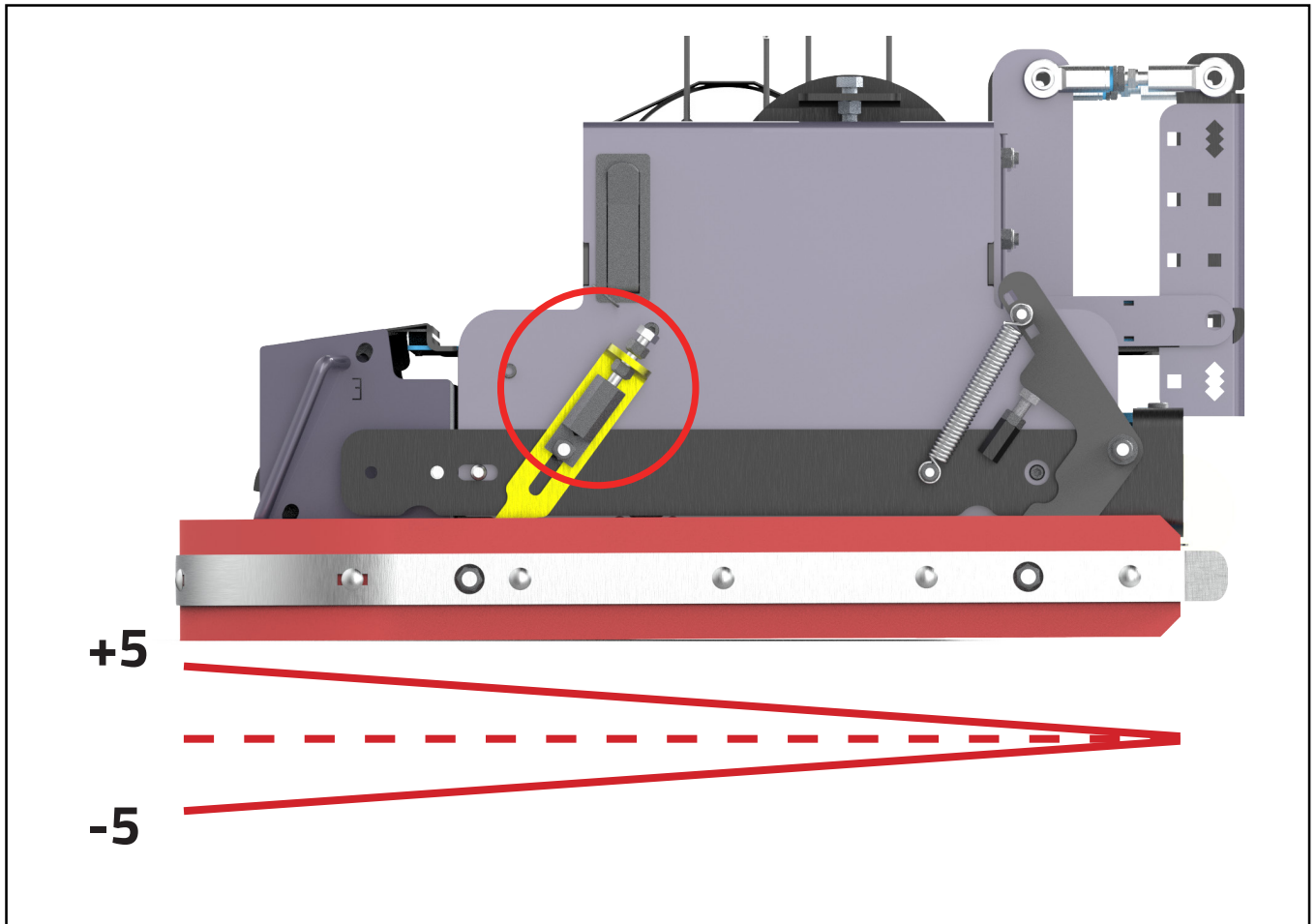
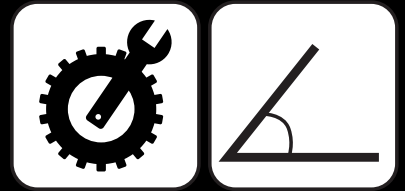



ADJUST SIDE SQUEEGEE

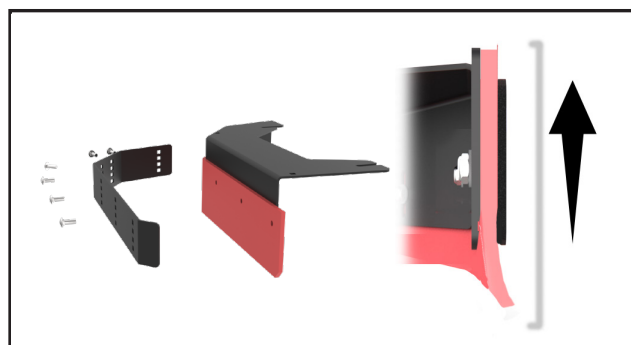
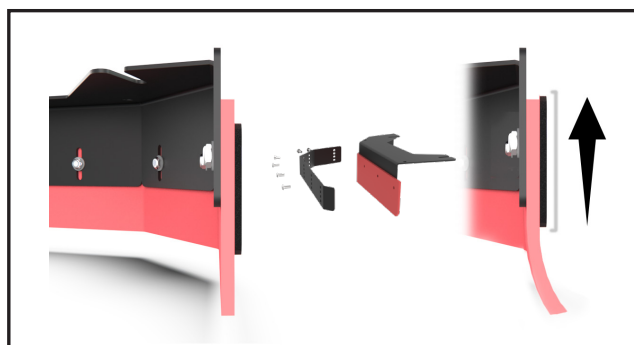
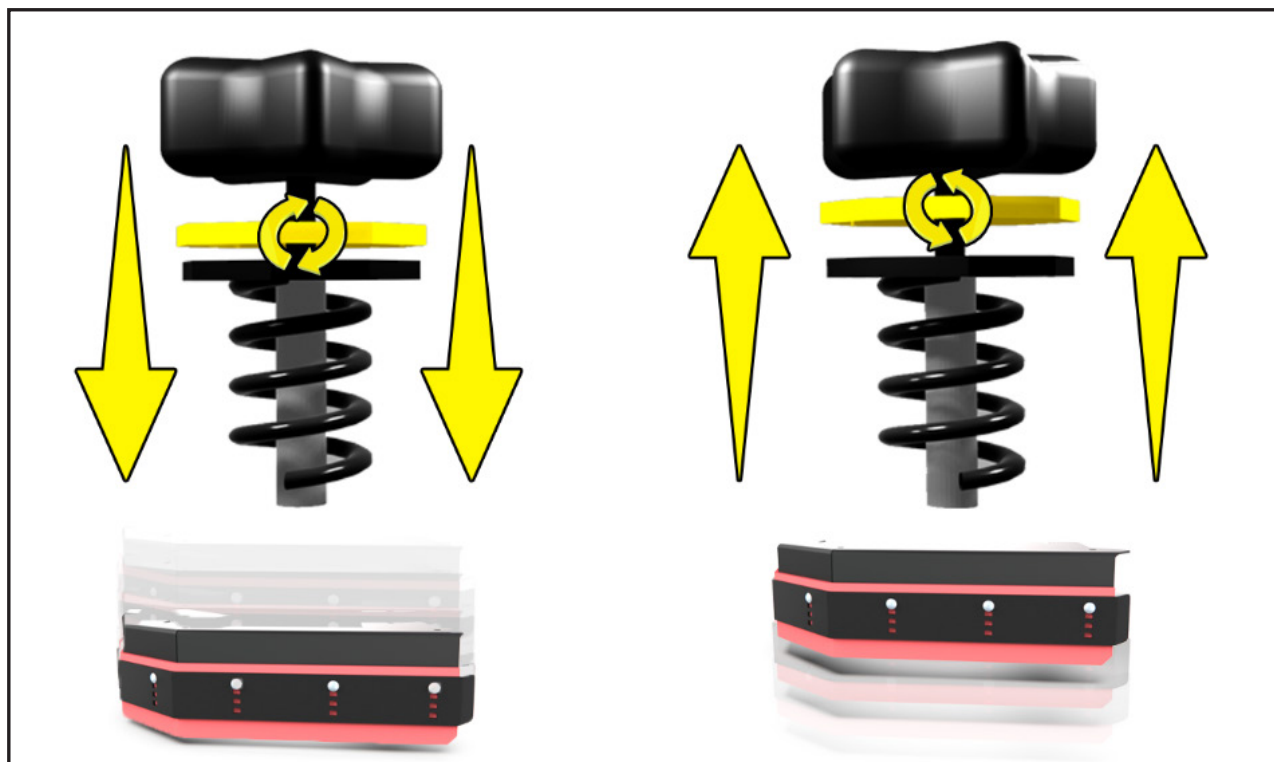
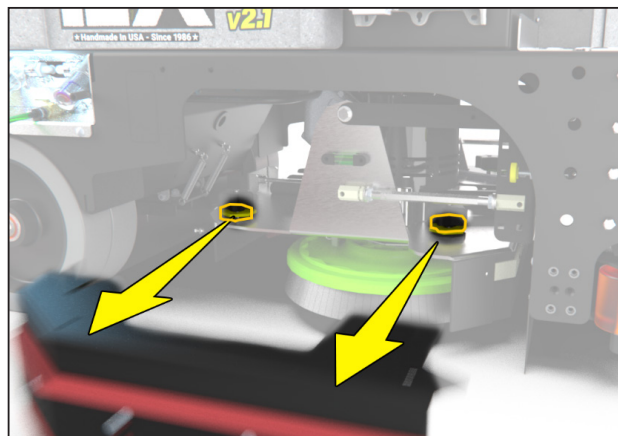
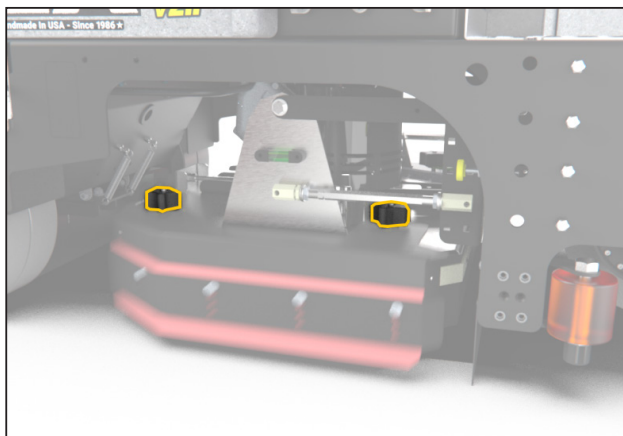

ADJUST SQUEEGEE

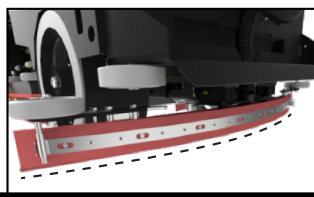
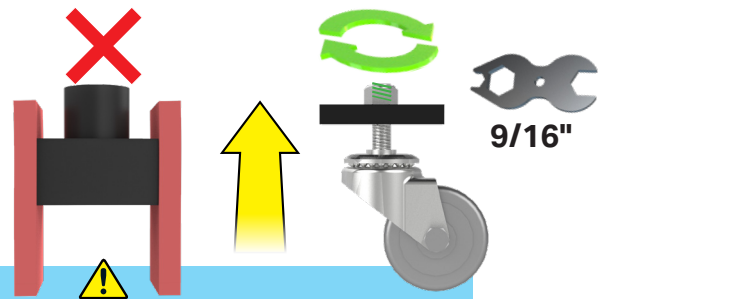
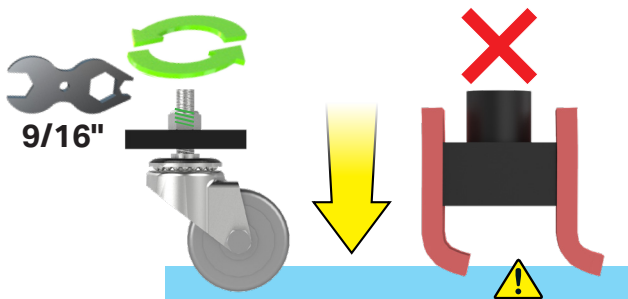
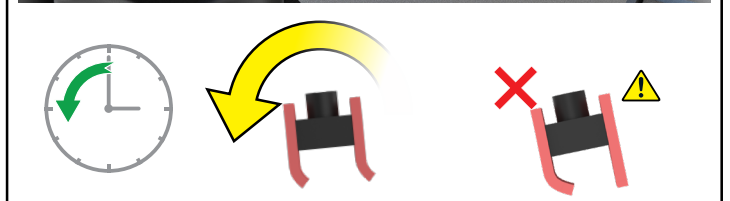
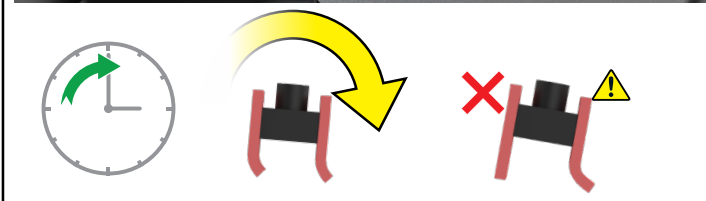
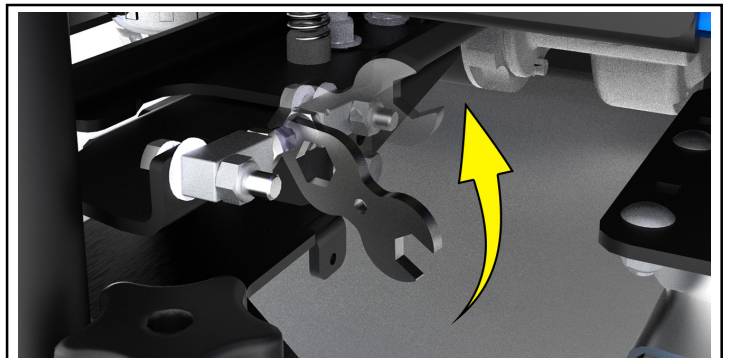
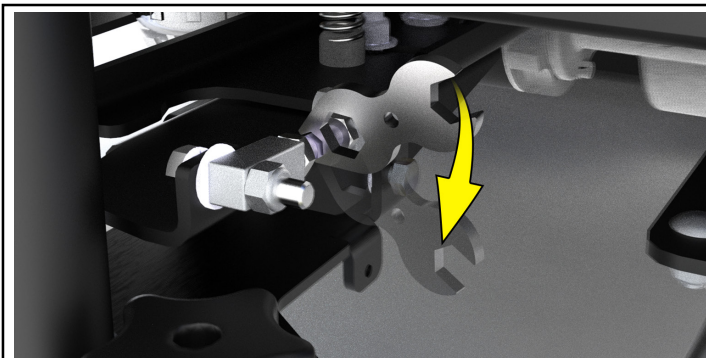
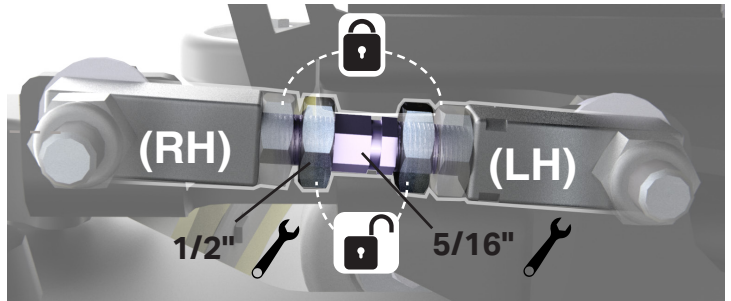
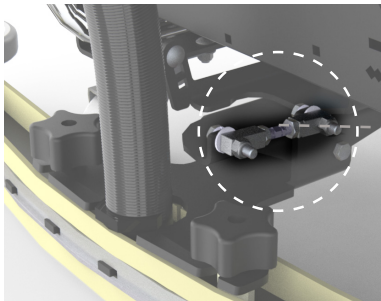
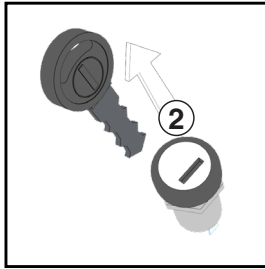
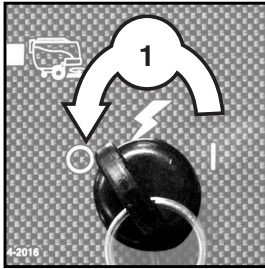



TRANSPORTATION - FORWARD

1

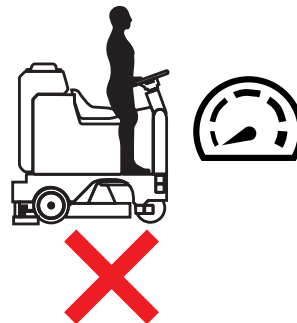
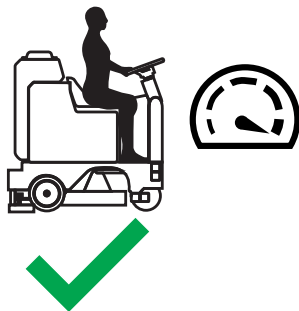
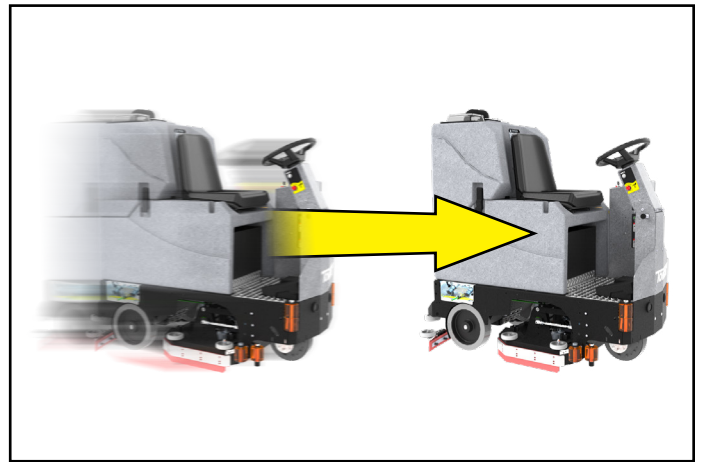
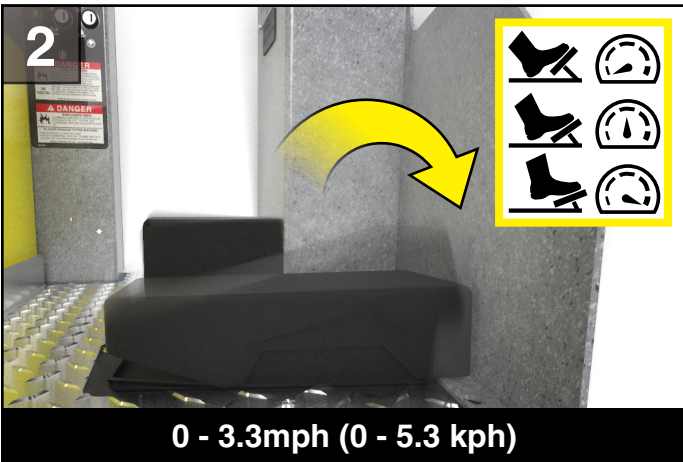
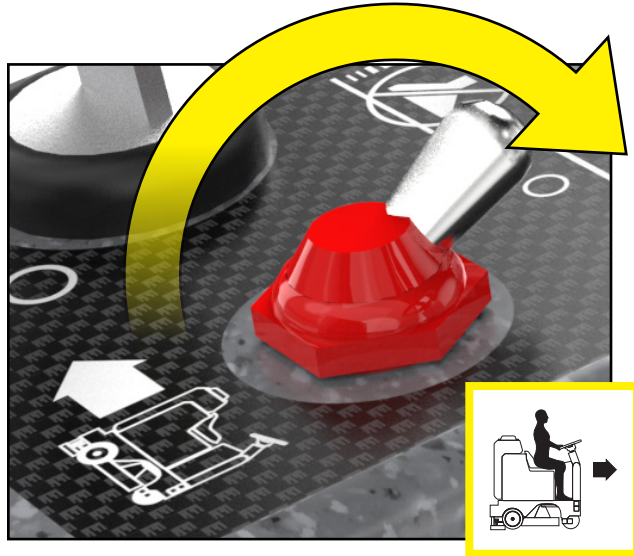
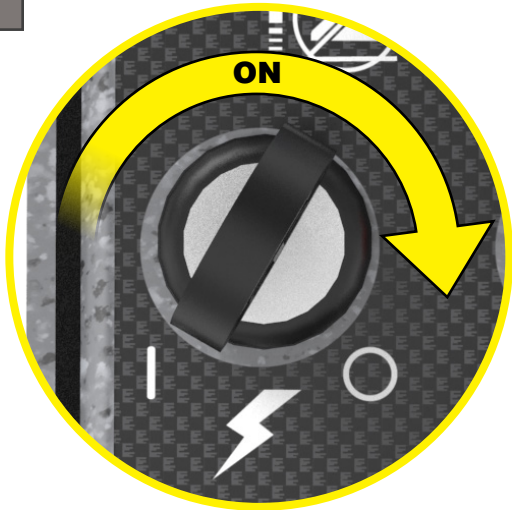

TRANSPORTATION - REVERSE



1

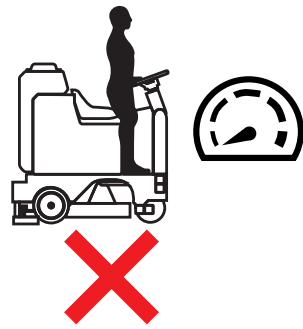
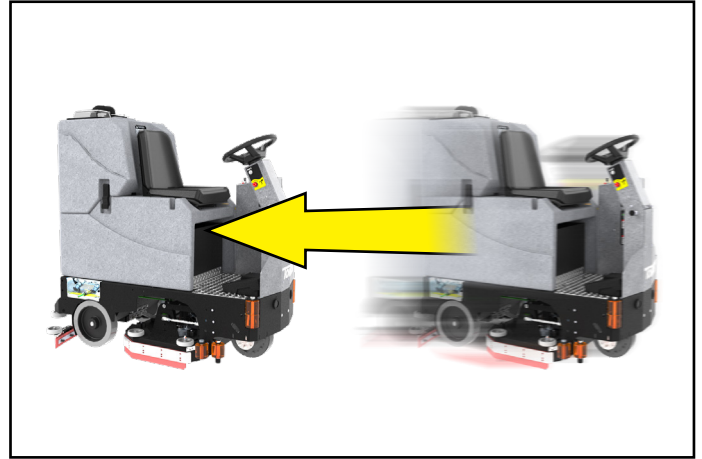
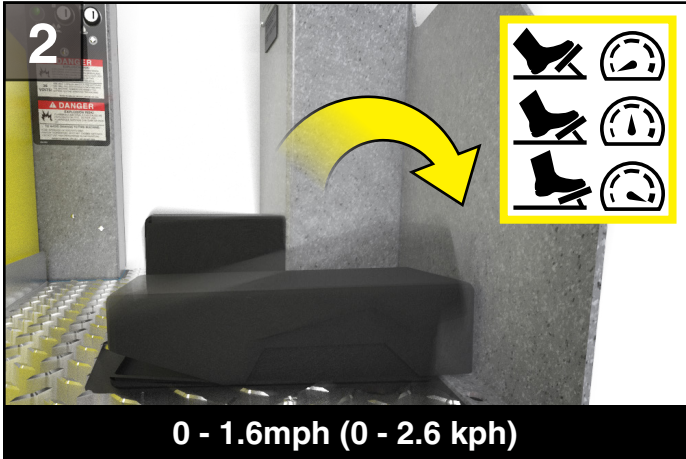
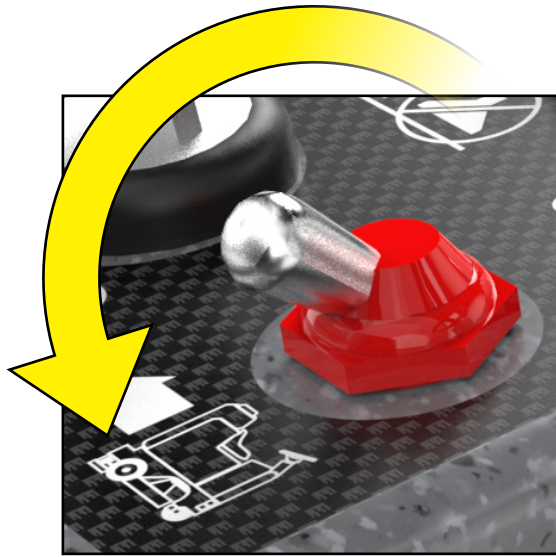
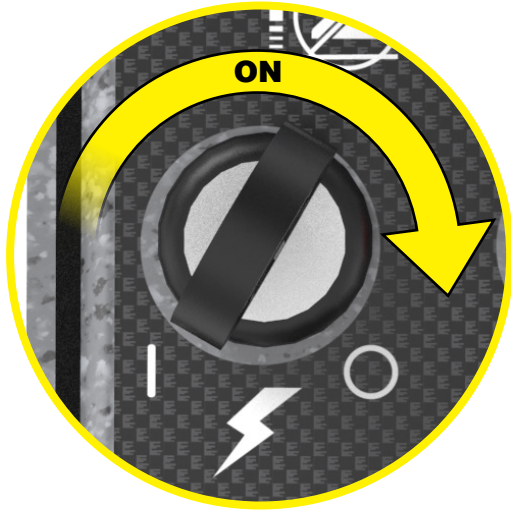



FILL SOLUTION TANK

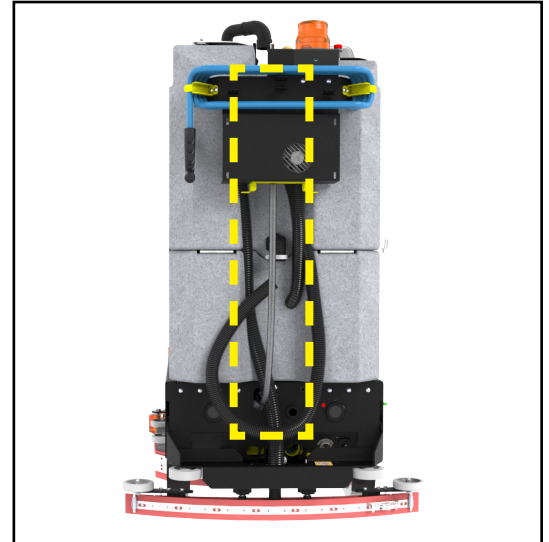
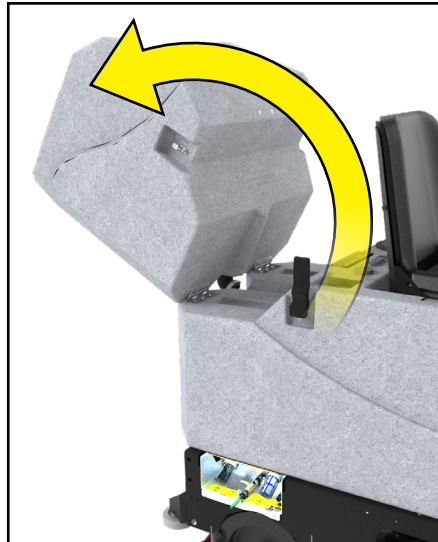

⚠ DANGER

EXPLOSION RISK!
FLAMMABLE MATERIALS CAN CAUSE AN EXPLOSION OR FIRE. DO NOT USE FLAMMABLE MATERIALS IN TANK OR PICK UP.

TO AVOID DAMAGE TO THIS MACHINE:

- USE APPROVED DETERGENTS ONLY
- WATER TEMPERATURE MUST NOT EXCEED 130°F/54°C
- DO NOT USE HIGH-PERCENTAGE BLEACH MIXTURE

REFER TO MANUAL OR CALL +011-262-661-3583

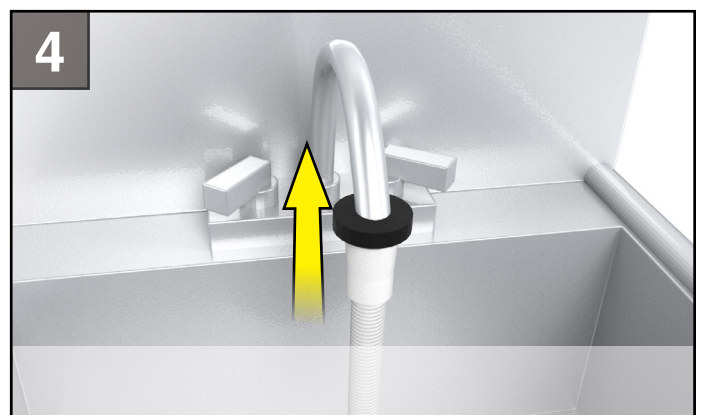
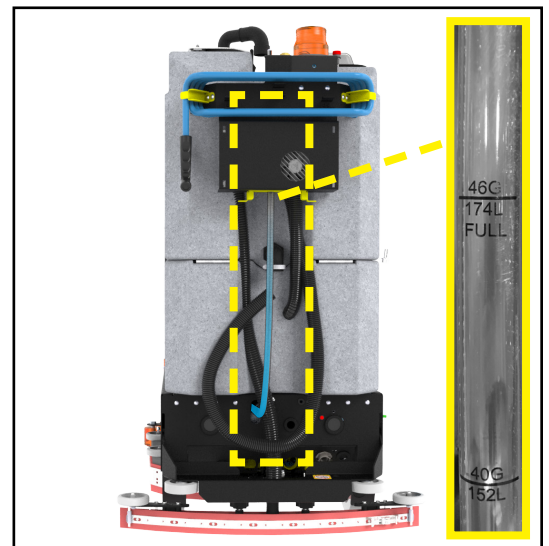

OPERATION - SCRUBBING



1

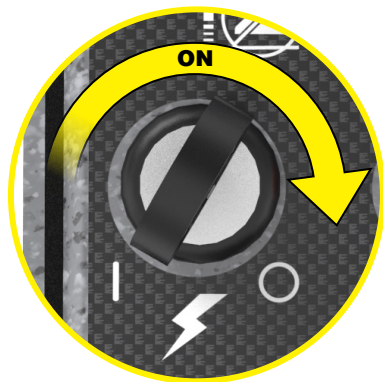

See page 7 for military grade controls

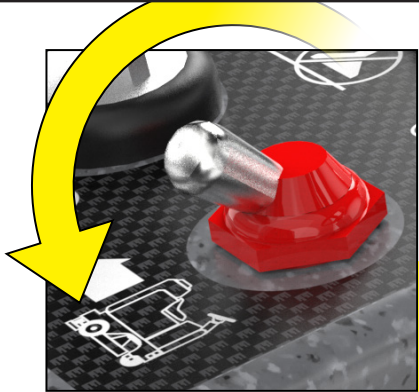

See page 7 for Legacy controls

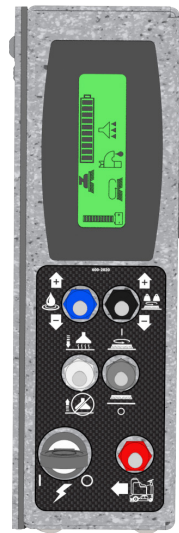

See page 10 for Touch Screen Controls

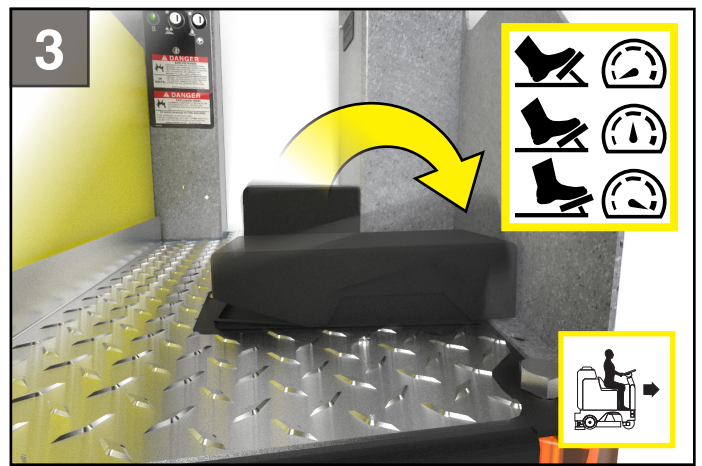

3 Gal. (124 l)

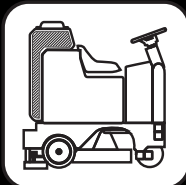

DRAINING RECOVERY TANK

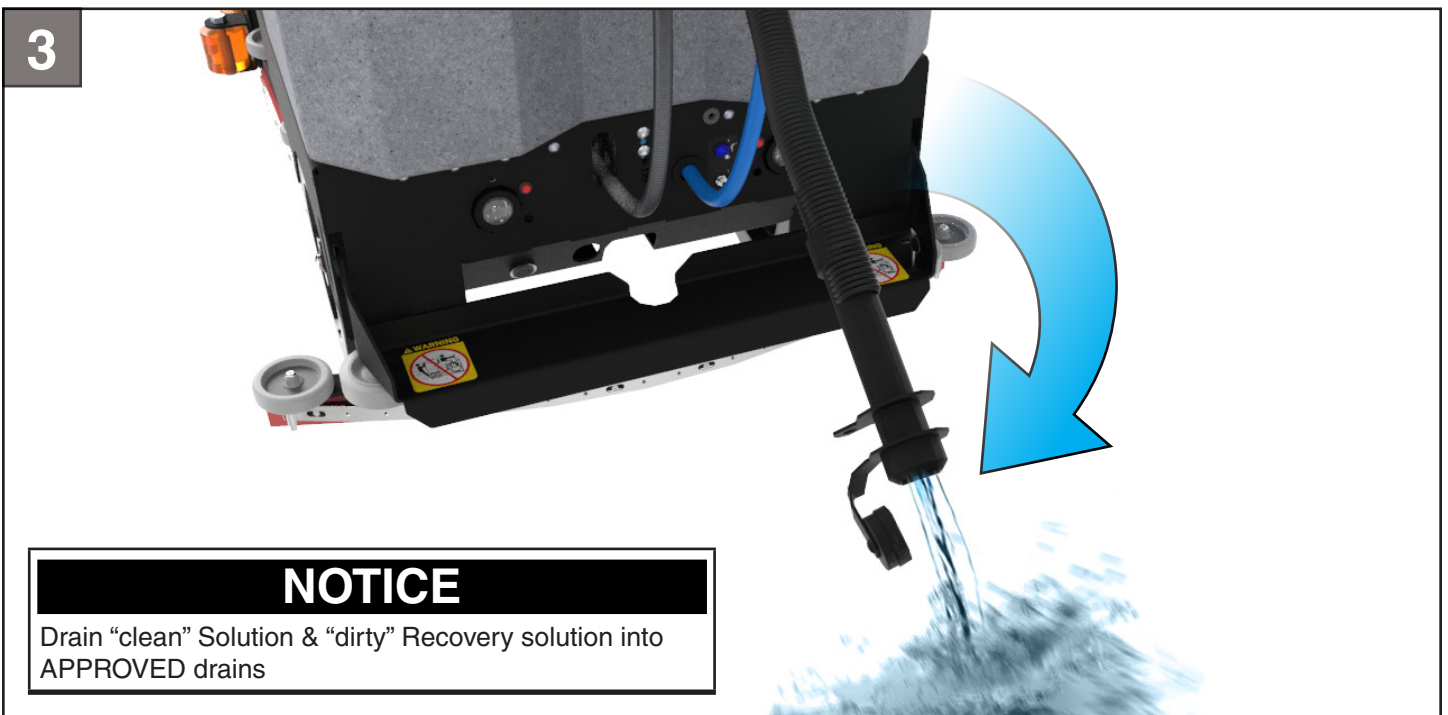
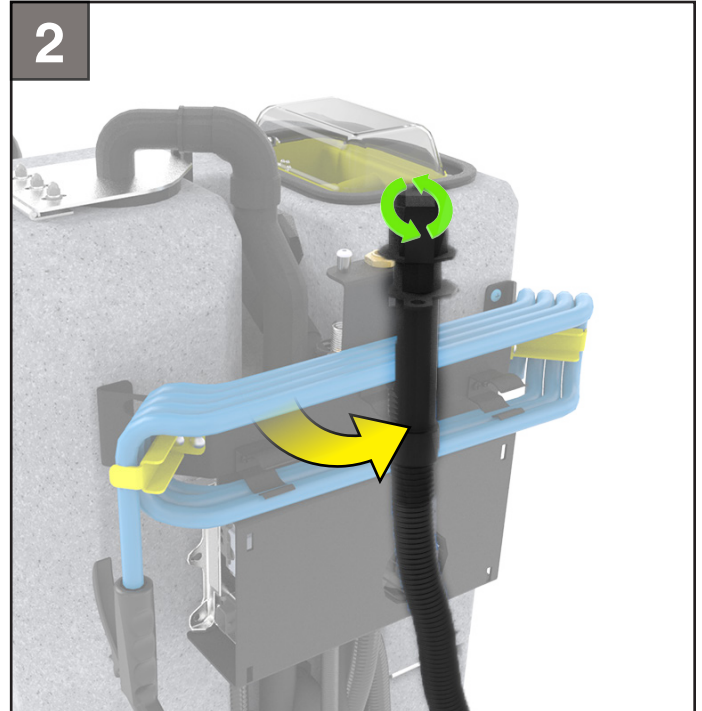
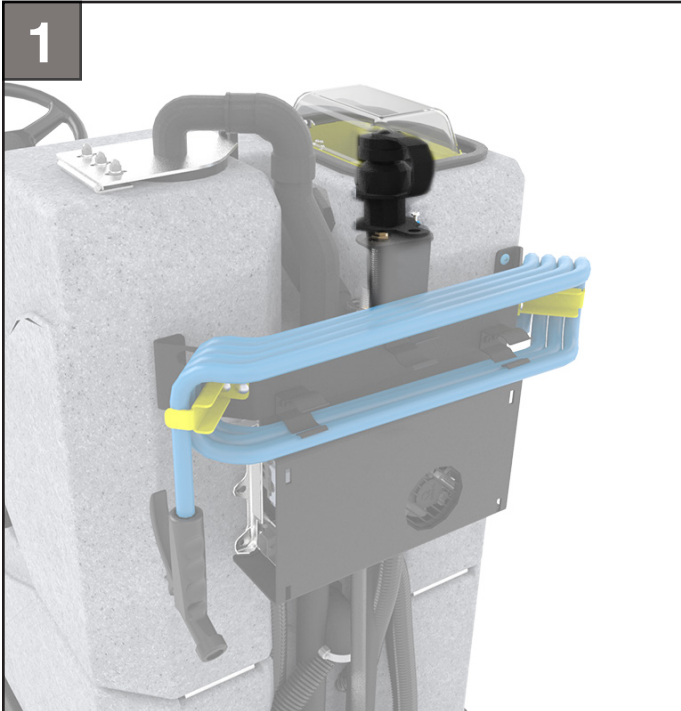

NOTICE

Drain "clean" Solution & "dirty" Recovery solution into APPROVED drains

DRAINING SOLUTION TANK

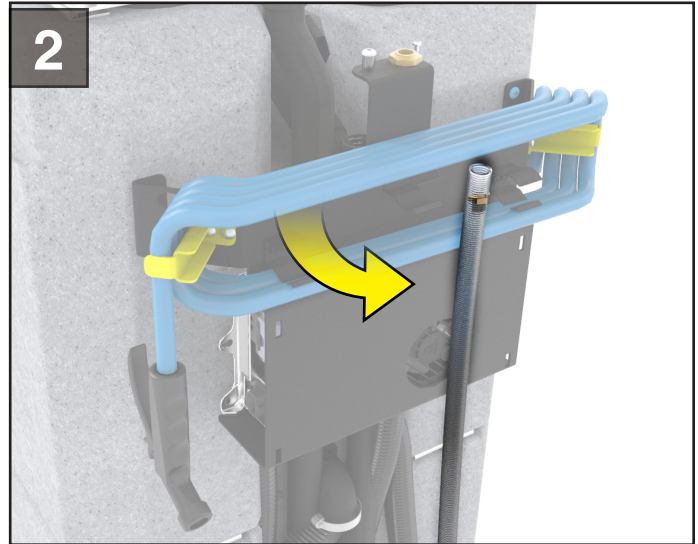
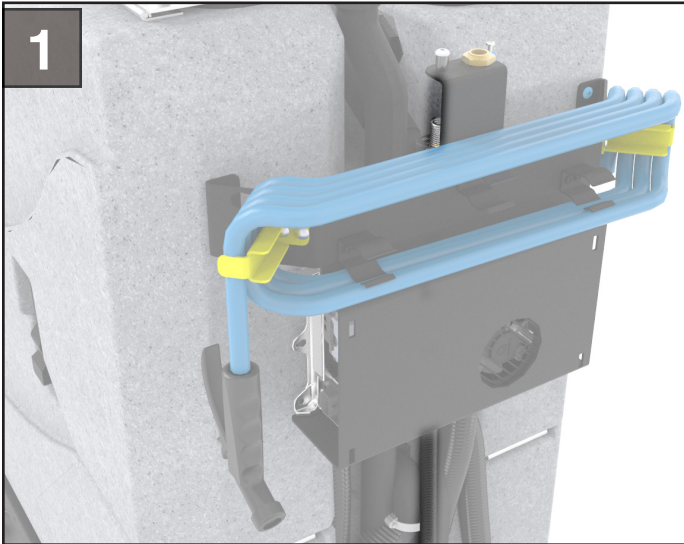

NOTICE
Drain "clean" Solution & "dirty" Recovery solution into APPROVED drains

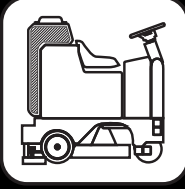

FLUSHING RECOVERY TANK

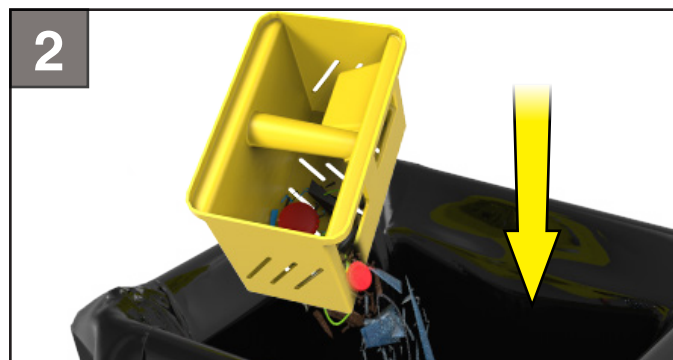
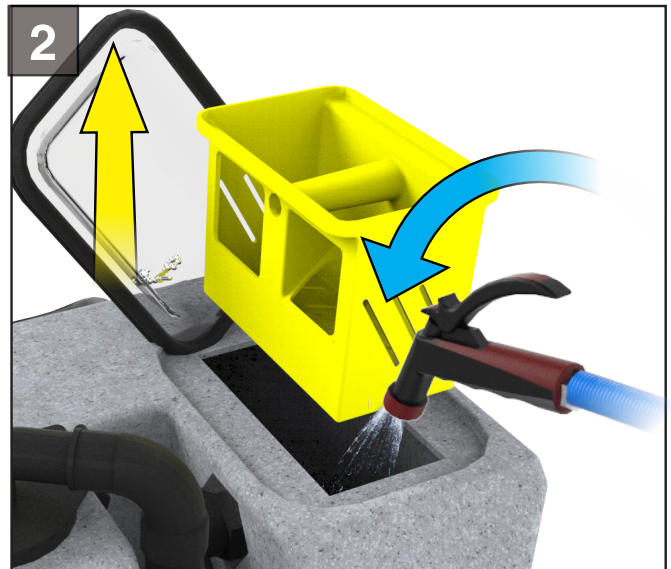
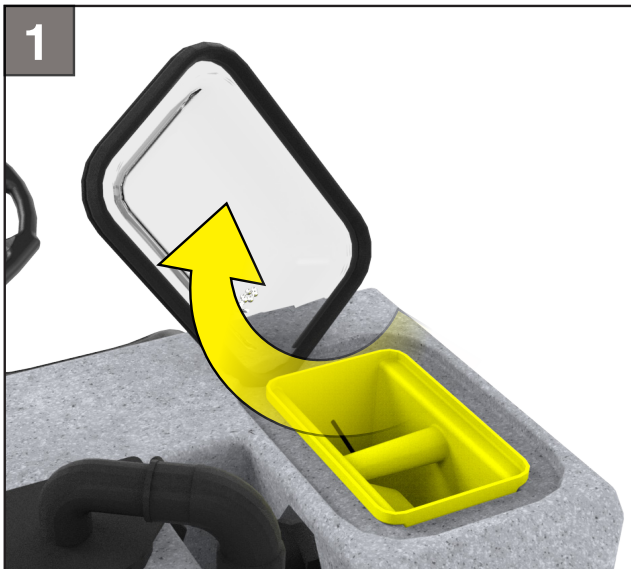

CLEAN DRAIN SAVER & VAC SYSTEM

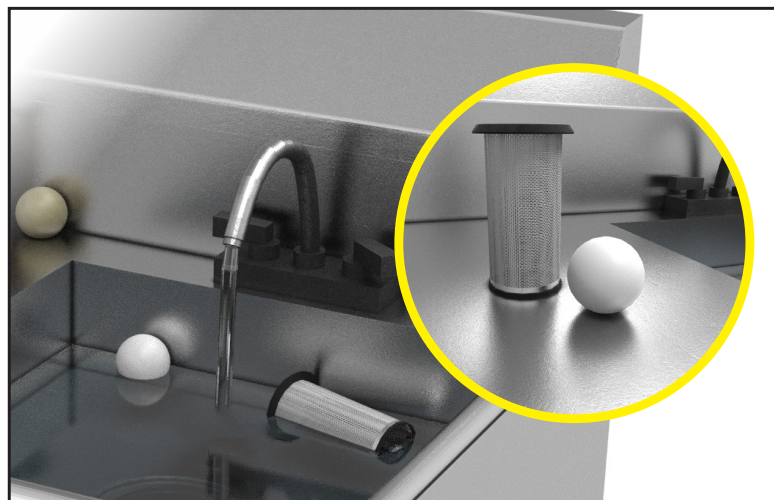
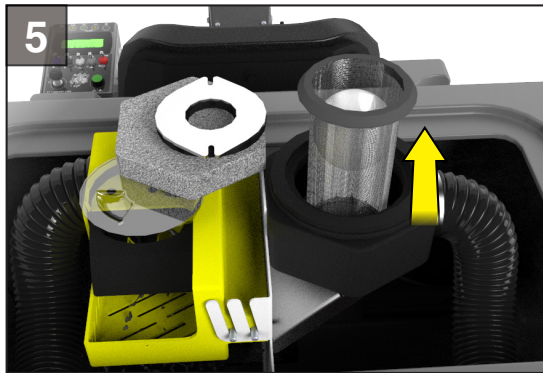
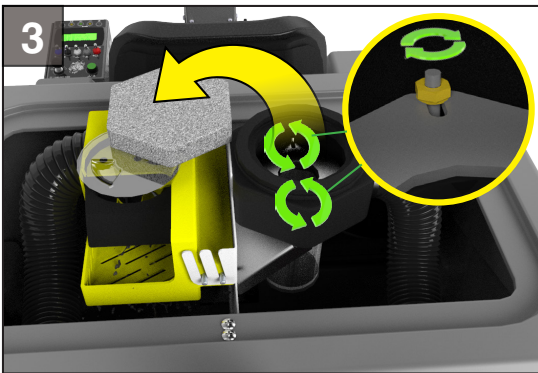
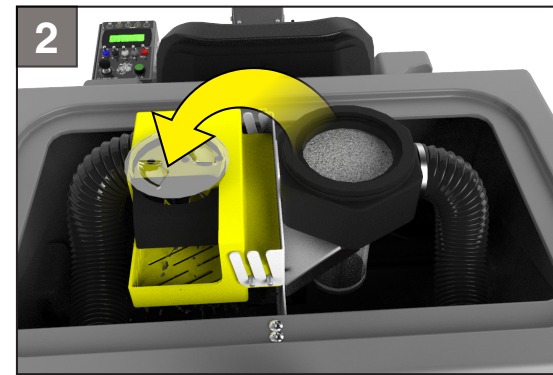
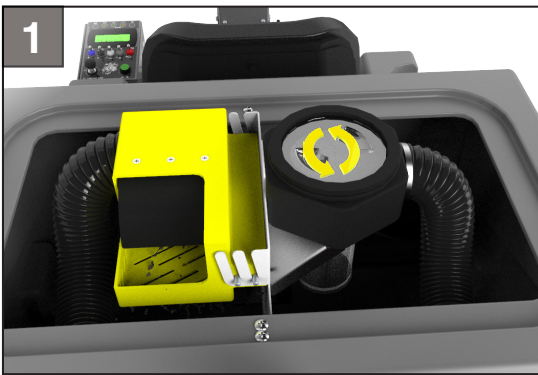
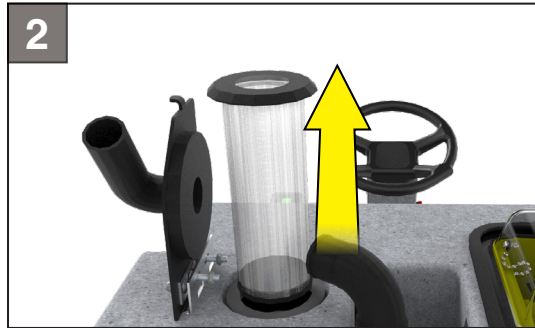
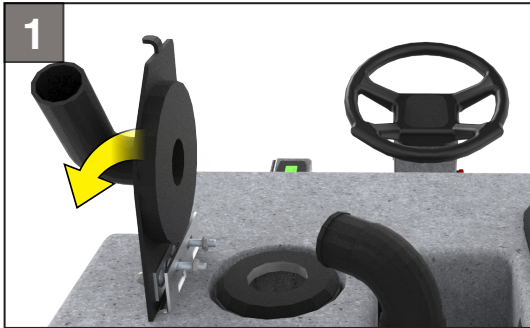



CLEAN CYLINDRICAL HOPPER

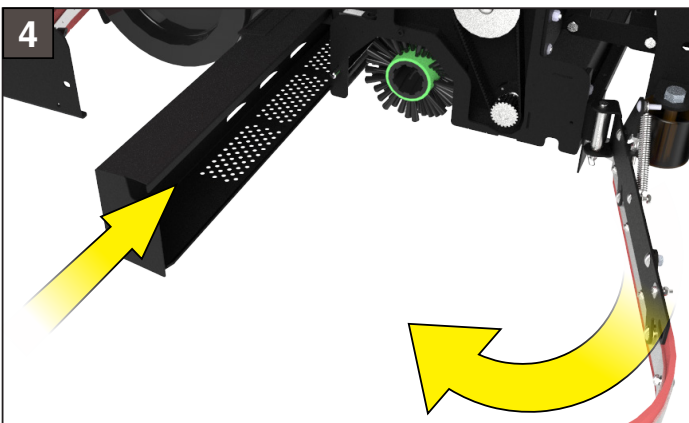
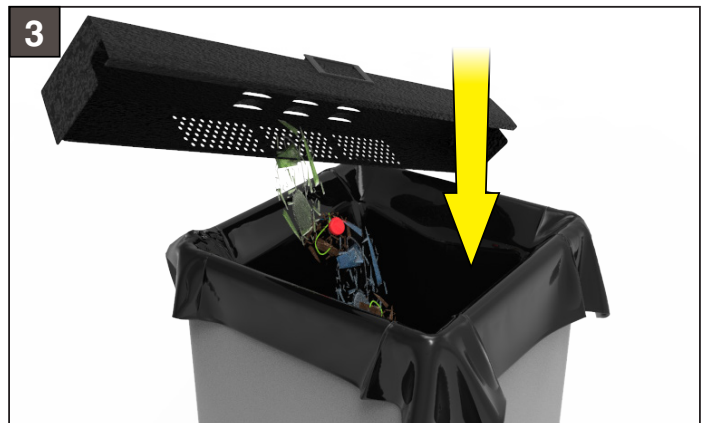
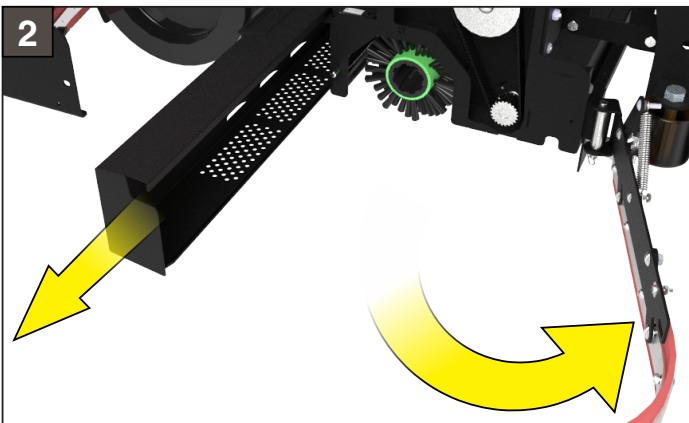
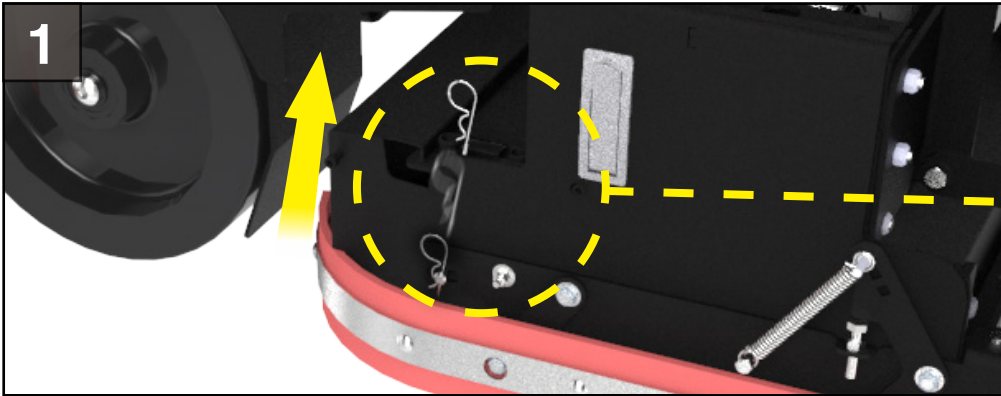

REMOVE DISK BRUSHES

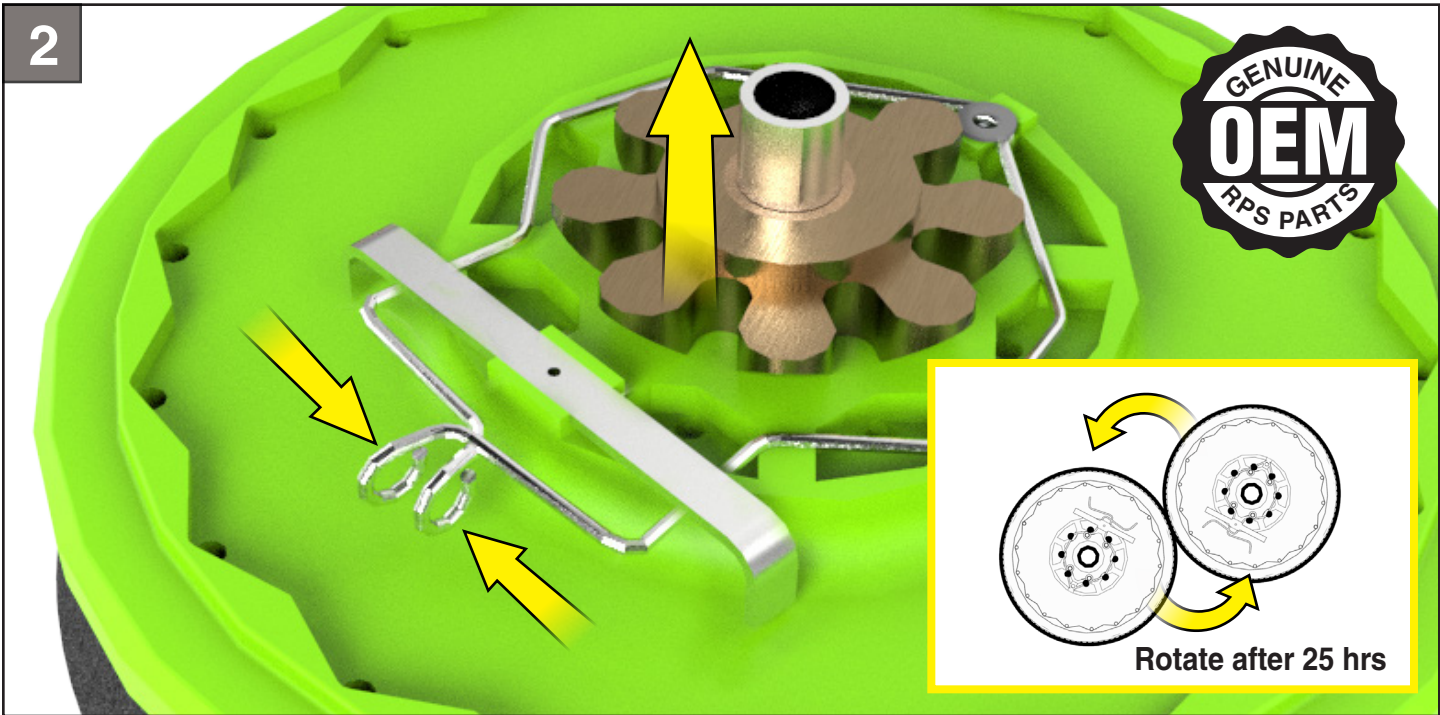
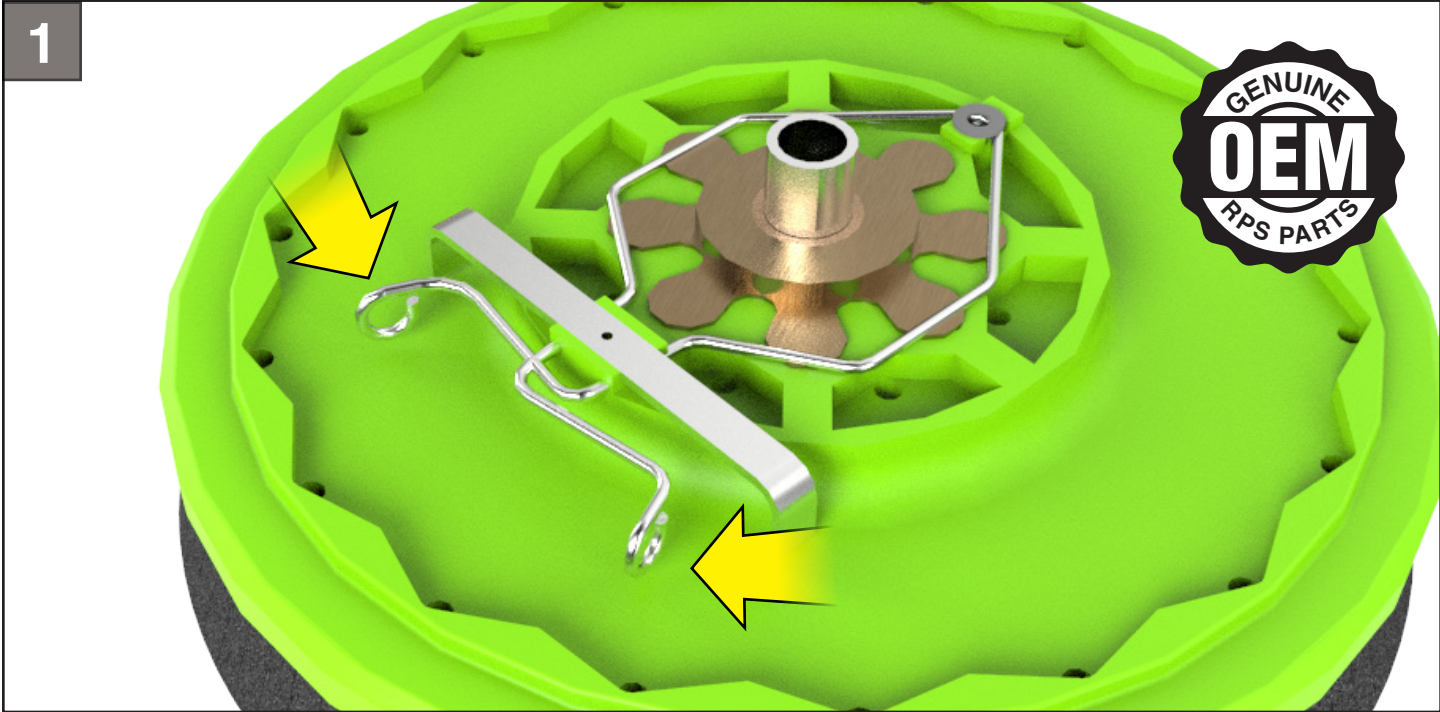

Replace brush when fibers reach 1/4 inch in length

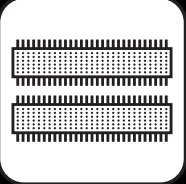

REMOVE CYLINDRICAL BRUSHES

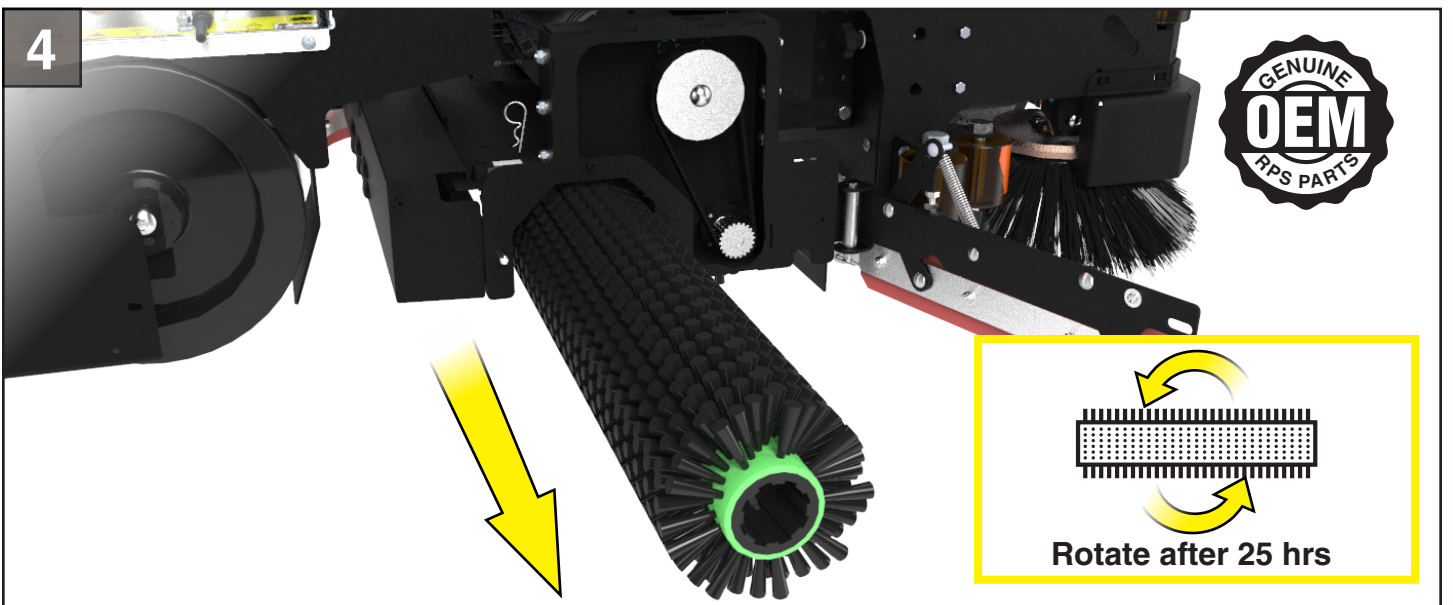
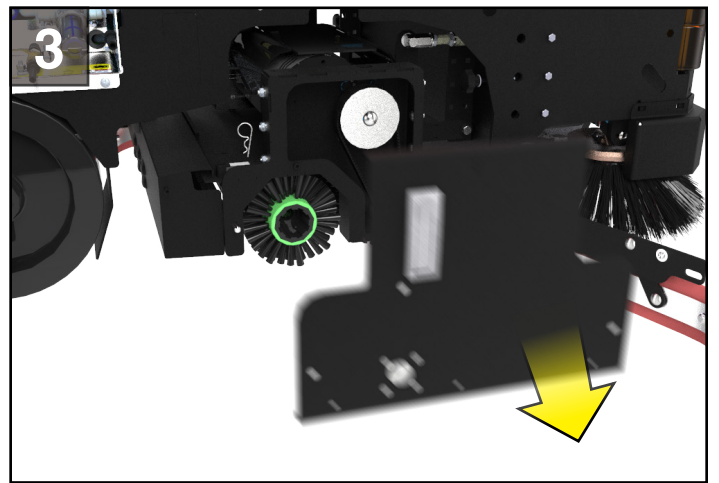
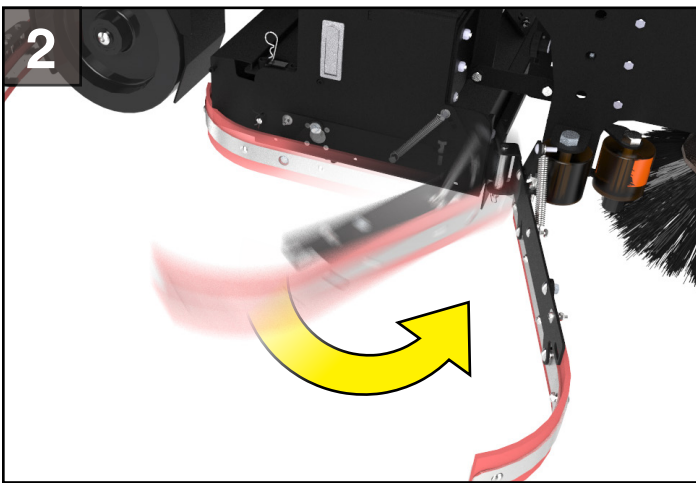
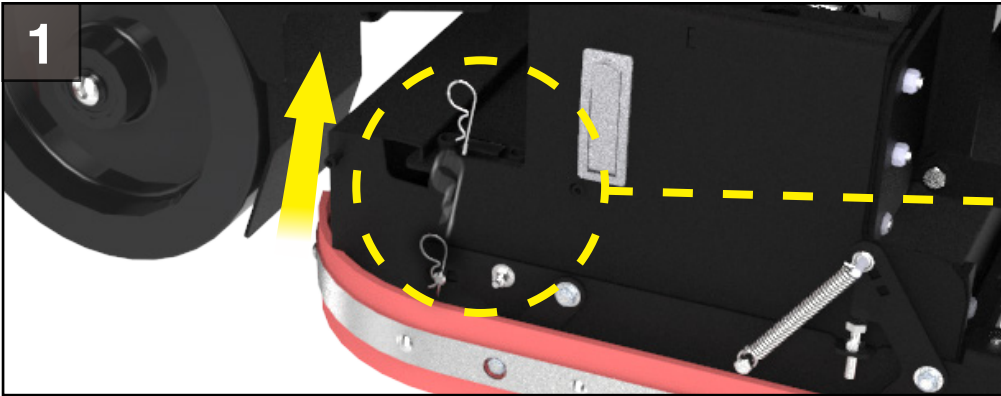

Replace brush when fibers reach 1/4 inch in length

PARKING BRAKE



! WARNING

Do not park this machine on ramps or slopes. Always park this machine on a level, hard surface. Do not operate this machine outdoors or on uneven surfaces.

! WARNING

Understand the dynamic braking system before you operate the machine on ramps. Machine may coast.

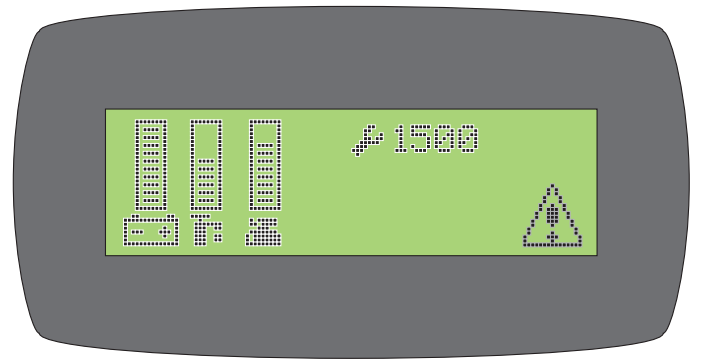
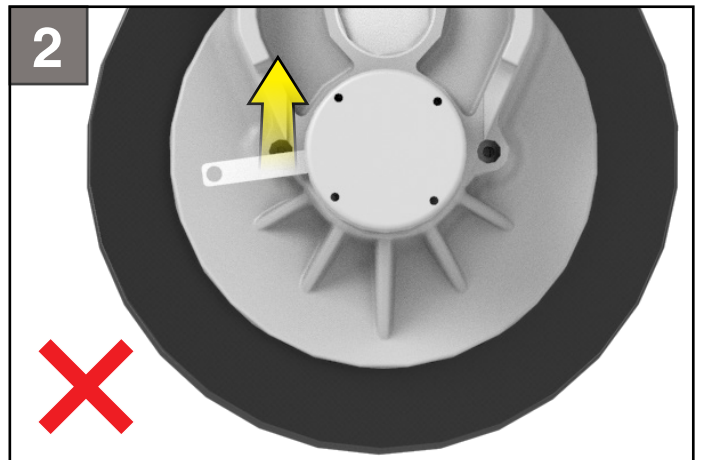
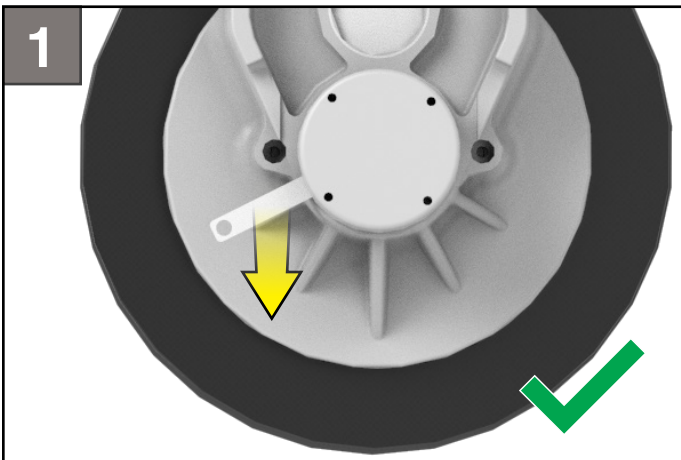
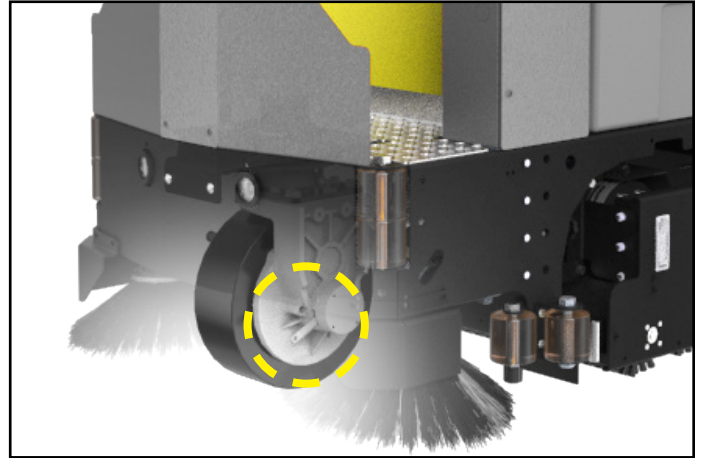

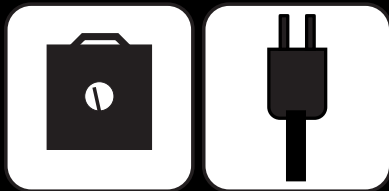

BATTERY CHARGERS

Console / WET / Domestic Chargers:



AC Power IN: 120VAC / 60Hz

DC Power OUT:

Pilot - 36VDC / 25A

GTX - 36VDC / 25A / 35A

GTR - 36VDC / 35A

Please refer to OEM Charger Operating Instructions for more information.



Onboard / AGM / International Chargers:



AC Power: 80-270VAC / 50-60Hz

DC Power OUT: 36VDC / 33A

Please refer to OEM Charger Operating Instructions for more information.



P&G CONTROLLER COMMON ERROR CODES

Below are common diagnostic codes and some typical causes / remedies. If the information provided in the "Correction" section does not cure the code, seek technical support from your local authorized RPS Corporation distributor.

Diagnostic Code	Cause	Correction
1501	Parking brake is released or the parking brake coil circuit is open	Check to assure the parking brake is not manually released.
1507	Parking Brake Over Current	Parking brake coil is internally shorted or there is a problem with the wiring to the brake.
2C00-2C02	Battery voltage is low	Charge the batteries with OEM supplied charger.
2F01	Throttle is depressed during power on or a fault with the throttle system	Turn the machine off, assure that the throttle button(s) or throttle pedal are not depressed. Turn the machine back on and if the condition persists, seek technical support from your local authorized RPS distributor
3101	Brush / Vac Motor - Precharge Fault	This code can be caused by the scrub or vacuum motor(s) having moisture present or contaminated with debris.
3102	Traction Motor - Precharge Fault	This code can be caused by the traction motor having moisture present or being contaminated.
7600	Brush Motor Circuit Open	The controller is not seeing continuity on the brush motor circuit. This can be caused by the wiring to the scrub brush motor(s), corroded connections or a faulty motor.
7601-7603	Brush Motor Circuit Over Current	The brush motor output is exceeding its limit. With the scrubber turned off, check for entrapped debris around the brush driver(s) and assure the brushes turn freely.
7700	Vacuum Motor Circuit Open	The controller is not seeing continuity on the vacuum motor circuit. This can be caused by the wiring to the scrub brush motor(s), corroded connections or a faulty motor.
7701-7703	Vacuum Motor Circuit Over Current	The vacuum motor output is exceeding its limit. This can be caused by a faulty vacuum motor(s) or damaged vacuum motor wiring.
1E03	Charger / Seat Switch – Charger is plugged in or operator is not on the seat of ride on equipment.	On board charger is plugged into the wall outlet. Off board charger is plugged into charging port. The switch at the charger plug for an external charger is out of adjustment. (Operator is not present on seat GTR and EX machines Prior to Serial Number 100xxx)
7500	LCD Communication Error	The LCD lost communication to the controller. Check the 6 wire harness between the LCD module and it's connections.
7801-7802	Traction Motor Over Current	The traction motor output is exceeding its limit. Check to assure the parking brake is releasing when the throttle is engaged. Assure all wheels that contact the floor turn freely.
7804	Boost Mode	The code 7804 indicate the controller is in Boost Mode and considered normal under hard acceleration or when climbing a hill.
7900	Emergency Stop Activated	The emergency stop is activated. If the machine is not equipped with an emergency stop switch typically the LCD module has failed.

TOUCH SCREEN ERROR CODES

Error	Internal Label	Code	Type	Description	Action	Remedy
Vacuum motor current over software limit	VACUUM_SOFTWARE_OV	49	soft	The vacuum motor current has exceed the software limit	The vacuum motor is disabled	
Squeegee motor current over hardware limit	SQUEE_HARDWARE_OV	50	soft	The squeegee motor current has exceed the absolute hardware limit	The squeegee actuator is disabled	
	VALVE_FAULT	51				
Open circuit detected in vacuum motor	VACUUM_OPEN_CIRCUIT	52	soft	An electrically open condition has been detected in the vacuum motor circuit	The vacuum motor is disabled	
	TRACT_RIGHT_NULL_ERROR	53				
	TRACTION_OPEN_CIRCUIT	54				
Open circuit detected in deck actuator	BRUSH_DECK_OPEN_CIRCUIT	55	soft	An electrically open condition has been detected in the deck actuator circuit	Brush, deck actuator and water/suds are disabled	
	TRAIL_TIME_OUT	56				
	SOLENOID_WELDED_OTHER	57				
	SOLENOID_CLOSE_LIMIT_WARNING	58				
Squeegee motor stalled	SQUEE_STALLED_MOTOR	59	soft	An energized squeegee actuator is not moving	The squeegee actuator is disabled	
Deck actuator stalled	BRU_DECK_STALLED_MOTOR	60	soft	An energized deck actuator is not rotating	Brush, deck actuator and water/suds are disabled	
	PRECHARGE_FAILURE_OTHER	61				
Brush motor stalled	BRUSH_STALLED_MOTOR	62	soft	An energized brush motor is not rotating	Brush, deck actuator and water/suds are disabled	
vacuum motor stalled	VACUUM_STALLED_MOTOR	63	soft	An energized vacuum motor is not rotating	The vacuum motor is disabled	
	LEFT_CURRENT_LIMIT	64				
	RIGHT_CURRENT_LIMIT	65				
Overheat MOSFET	THERMAL_CUTBACK_MOS	66	hard	The transport motor drive circuit has had an over temperature failure	The machine is disabled	
Battery over voltage	HIGH_BATTERY_PROTECT	67	hard	The battery voltage is above acceptable limits	The machine is disabled	check batteries / wiring

TOUCH SCREEN ERROR CODES

Error	Internal Label	Code	Type	Description	Action	Remedy
	HARD_FAULT	0		Flag used to define a show-stop-per failure requiring a power cycle		
	SOFT_FAULT	1		Flag used to define an error that may disable a device but keep the rest of the machine operational		
	NO_ERROR	0		Used internally		
Bad Personality	BAD_PERSONALITY	10	hard/soft	Incompatible options programmed or a checksum failure	The machine is disabled or continues operating with factory default parameters	Check programming options and/or reprogram EEPROM
Initial throttle fault	INITIAL_THROTTLE_FAULT	11	soft	Throttle is engaged at power up preventing a successful return to idle state	Machine remains in a pre-idle condition until the active throttle condition goes away	Take your foot off the gas
	SHORT_CIRCUIT	12	hard			
Memory fault	EEPROM_READ_ERROR	13	hard/soft	An error was detected during an EEPROM read access	The machine is disabled or continues operating with factory default parameters	Cycle keyswitch. If problem persists change control board
Dead battery	LOW_BATTERY_PROTECT	14	hard	The battery voltage has dropped below NN.n Volts	The machine is disabled	Charge or replace batteries
Low battery charge	LOW_BATTERY_CHARGE	15	soft	The battery voltage has dropped below NN.n Volts and all but the transport motor have been disabled	All but the transport motor are disabled	Charge battery
Overheat CPU	THERMAL_CUTBACK_MCU	16	hard	The microcontroller hardware has had an over temperature failure	The controller is switched off	Keyswitch off, wait ten minutes, keyswitch on. If problem persists change control board
	PRECHARGE_FAILURE_TRA	17				
Transport idle current fault	TRACT_LEFT_NULL_ERROR	18	hard	An abnormally high idle current has been detected in the transport motor (operational motor)	The machine is disabled	
Brush idle current fault	BRUSH_NULL_ERROR	19	soft	An abnormally high idle current has been detected in the brush motor (operational motor)	Brush, deck actuator and water/suds are disabled	
Vacuum idle current fault	VACUUM_NULL_ERROR	20	soft	An abnormally high idle current has been detected in the vacuum motor (operational motor)	Vacuum motor is disabled	
Squeegee idle current fault	SQUEEGEE_NULL_ERROR	21	soft	An abnormally high idle current has been detected in the squeegee motor (operational motor)	Squeegee motor is disabled	
	BRU_ADJ_OUT_OF_RANGE	22	soft			
Transport motor relay not open	SOLENOID_WELDED_TRA	23	hard	The main traction relay was detected closed during power on	The machine is disabled	Keyswitch off, wait ten seconds, keyswitch on. If problem persists change control board
Transport motor relay not closed	SOLENOID_DIDNT_CLOSE_TRA	24	hard	The main traction relay was detected open after being energized during power on	The machine is disabled	
Throttle fault	THROTTLE_FAULT	25	hard	An illegal voltage has been read from the throttle feedback circuit	The machine is disabled	Check throttle action and voltages

TOUCH SCREEN ERROR CODES

Error	Internal Label	Code	Type	Description	Action	Remedy
Brake fault	BRAKE_FAULT	26	hard	An illegal voltage has been read from the brake feedback circuit	The machine is disabled	
Alarm fault	ALARM_FAULT	27	soft			
Auxilliary output 1 fault	AUX_1_FAULT	28	soft			
Auxilliary output 2 fault	AUX_2_FAULT	29	soft			
Auxilliary output 3 fault	AUX_3_FAULT	68	soft			
Deck actuator idle current over limit	BRU_DECK_NULL_ERROR	30	soft	An abnormally high idle current has been detected in the deck actuator motor	Brush, deck actuator and water/suds are disabled	
Transport motor stalled	TRACTION_STALLED_MOTOR	31	hard	An energized transport motor is not rotating		
Transport motor circuit current over limit	LEFT_DRAIN_OV	32	hard	There is excessive current in the transport motor drive circuit		
Transport motor circuit current over limit	RIGHT_DRAIN_OV	33	hard	There is excessive current in the transport motor drive circuit	The machine is disabled	
Brush motor current over software limit	BRUSH_SOFTWARE_OV	34	soft	The brush motor current has exceed the software limit	Brush, deck actuator and water/suds are disabled	
Brush motor current over hardware limit	BRUSH_HARDWARE_OV	35	soft	The brush motor current has exceed the absolute hardware limit	Brush, deck actuator and water/suds are disabled	
Open circuit detected in brush motor	BRUSH_OPEN_CIRCUIT	36	soft	An electrically open condition has been detected in the brush motor circuit	Brush, deck actuator and water/suds are disabled	
	REGEN_CURRENT_EXCEEDED	37				
	LEFT_DRAIN_FAULT	38				
	RIGHT_DRAIN_FAULT	39				
Transport motor current over hardware limit	LEFT_SOFTWARE_OV	40	hard	The transport motor current has exceed the absolute hardware limit	The machine is disabled	
Transport motor current over hardware limit	RIGHT_SOFTWARE_OV	41	hard	The transport motor current has exceed the absolute hardware limit	The machine is disabled	
	BRUSH_DRAIN_FAULT	42				
12VDC power supply outside acceptable limits	SUPPLY_OUT_OF_RANGE	43	hard	The 12VDC supply voltage is less tha 11.75V or greater than 12.25 volts	The machine is disabled	check batteries
	VALVE_OPEN_CIRCUIT	44				
Deck actuator motor current over software limit	BRU_DECK_SOFTWARE_OV	45	soft	The deck actuator current has exceed the software limit	Brush, deck actuator and water/suds are disabled	
Vacuum motor current over hardware limit	VACUUM_HARDWARE_OV	46	soft	The vacuum motor current has exceed the software limit	The vacuum motor is disabled	
Deck actuator motor current over hardware limit	BRU_DECK_HARDWARE_OV	47	soft	The deck actuator current has exceed the absolute hardware limit	Brush, deck actuator and water/suds are disabled	
Squeegee motor current over software limit	SQUEE_SOFTWARE_OV	48	soft	The squeegee motor current has exceed the software limit	The squeegee actuator is disabled	

MILITARY GRADE CENTRAL COMMAND - STATUS LIGHT CODES

Status Light Guide

Below is a list of self-help actions. Try to use this list before you contact your service agent. Go to the number in the list which matches the number of indicator light flashes and follow the instructions.

1 Flash



The battery needs charging, there is a bad connection to the battery or dependent on programming, may indicate that the battery lockout function is active and the controller is in a restricted mode of operation. Check the connections to the battery. If the connections are good, try charging the battery.

2 Flash



There is a bad connection to the motor. Check all connections between the motor and the controller.

3 Flash



The motor has a short circuit to a battery connection. Contact your service agent.

4 Flash



The battery charge level has fallen below the Battery Lockout Level and the controller is inhibiting certain machine functions. Charge the battery.

5 Flash



Not Used.

6 Flash



The controller is being inhibited from driving, this may be because the battery charger is connected.

7 Flash



A throttle fault is indicated. Make sure that the throttle is in the rest position before switching on the machine.

8 Flash



A controller fault is indicated. Make sure that all connections are secure.

9 Flash



The parking brakes have a bad connection. Check the parking brake and motor connections. Make sure the controller connections are secure.

10 Flash



An excessive voltage has been applied to the controller. This is usually caused by a poor battery connection. Check the battery connections.

CUSTOMER INFORMATION							
CUSTOMER				EMAIL			
ADDRESS					PHONE		
CITY		STATE		ZIP	CONTACT		
MACHINE INFORMATION							
MODEL #:			SERIAL #:				
WORK ORDER#:			HOUR METER (Key):				
CHASSIS HOUR METER:			HOUR METER (Traction):				
RE-CHARGE COUNTER:			HOUR METER (Scrub):				
ISOLATOR HOUR METER:			HOUR METER (Vac):				
NOTE: Isolators need to be replaced on Scrubber Machines at 1000 Hours or Annually							
BATTERY CONDITION		CELL 1	CELL 2	CELL 3	CELL 4	CELL 5	CELL 6
BATTERY 1 HYDROMETER							
BATTERY 1 ELECTROLYTE CLARITY <i>(Clear, Cloudy, Particulate, Dark)</i>							
BATTERY 1 WATER LEVEL <i>(Overfilled, Full, Low, Dry)</i>							
BATTERY 2 HYDROMETER							
BATTERY 2 ELECTROLYTE CLARITY <i>(Clear, Cloudy, Particulate, Dark)</i>							
BATTERY 2 WATER LEVEL <i>(Overfilled, Full, Low, Dry)</i>							
BATTERY 3 HYDROMETER							
BATTERY 3 ELECTROLYTE CLARITY <i>(Clear, Cloudy, Particulate, Dark)</i>							
BATTERY 3 WATER LEVEL <i>(Overfilled, Full, Low, Dry)</i>							
BATTERY 4 HYDROMETER							
BATTERY 4 ELECTROLYTE CLARITY <i>(Clear, Cloudy, Particulate, Dark)</i>							
BATTERY 4 WATER LEVEL <i>(Overfilled, Full, Low, Dry)</i>							
BATTERY 5 HYDROMETER							
BATTERY 5 ELECTROLYTE CLARITY <i>(Clear, Cloudy, Particulate, Dark)</i>							
BATTERY 5 WATER LEVEL <i>(Overfilled, Full, Low, Dry)</i>							
BATTERY 6 HYDROMETER							
BATTERY 6 ELECTROLYTE CLARITY <i>(Clear, Cloudy, Particulate, Dark)</i>							
BATTERY 6 WATER LEVEL <i>(Overfilled, Full, Low, Dry)</i>							
CLEAN BATTERY TOPS. CHECK BATTERY CABLE AND TERMINAL CONDITION.							
NOTES:							
PAD/BRUSH CONDITION							
SCRUB BRUSH FIBER LENGTH	ROTATED BRUSHES						
BROOM DRIVER SOCKETS (4)	GOOD	WORN	NEEDS REPLACEMENT				
DRIVER IDLER HUBS	GOOD	WORN	NEEDS REPLACEMENT				
SIDE BROOM CONDITION	GOOD	WORN	NEEDS REPLACEMENT	ROTATED SIDE TO SIDE			
DISK PAD DRIVER	GOOD	WORN	NEEDS REPLACEMENT				
EDGE/ORBITZ PAD GRIP FACE	GOOD	WORN	NEEDS REPLACEMENT				
CHECK OPERATION AND CONDITION OF:		IN SPEC	REPAIR	PROBLEM			
STEERING WHEEL TILT MECHANISM							
MAIN POWER SWITCH OR KEY SWITCH							
LCD DISPLAY							

PM SHEET

PAGE BUTTON			
BRUSH PRESSURE TOGGLE			
MANAGERS LOCK OUT			
REVERSE SWITCH			
BRUSH SWITCH			
SOLUTION +/- SWITCH			
SOLUTION SOLENOID			
LOW SOLUTION LIGHT			
BRUSH DECK LIFT SYSTEM			
BRUSH MOTORS			
VACUUM SWITCH			
VACUUM MOTOR PERFORMANCE			
OFF-BOARD VAC SWITCH			
SQUEEGEE LIFT SYSTEM			
SQUEEGEE ADJUSTMENT PITCH AND HEIGHT			
SQUEEGEE BLADES			
DRAIN HOSE AND PLUG			
SIDE BROOM OPERATION			
SPRAY JET PUMP, HOSE & NOZZLE			
BATTERY CHARGER CONNECTION & FUNCTION			
PITCH OF SCRUBDECK (MUST BE LEVEL)			
PITCH OF EDGE/ORBITZ DECK (MUST BE LEVEL)			
FOOTPEDAL			
PARKING BRAKE			
BACK UP ALARM (REVERSE ONLY)			

CLEAN AND / OR LUBRICATE	IN SPEC	REPAIR	PROBLEM
SOLUTION TANK CONDITION			
SQUEEGEE PIVOT POINTS & KNOBS			
SOLUTION FILTER CLEANING			
SCRUB DECK LINKAGE			
STEERING CHAIN			

VISUALLY INSPECT	IN SPEC	REPAIR	PROBLEM
SOLUTION TANK CONDITION			
RECOVERY TANK & GASKET CONDITION			
DRAIN SAVER			
VACUUM FLOATS & SCREENS			
VACUUM HOSES			
SOLUTION HOSES			
BLADE RETAINERS & HARDWARE			
SQUEEGEE WHEELS			
BRUSH SKIRTS			
REAR WHEELS CONDITION			
DRIVE WHEEL CONDITION			

COMMENTS

SERVICING DISTRIBUTOR: _____

TECHNICIAN'S NAME: _____ DATE: _____ SIGNATURE: _____

CUSTOMER'S NAME: _____ DATE: _____ SIGNATURE: _____

BLANK

THIS PAGE WAS INTENTIONALLY LEFT BLANK

FACTORYCAT[®]

1711 South Street
Racine, WI 53404
www.tomcatequip.com
262-681-4060